



<b>Product Name</b>	GAO Tek Temperature and Humidity Sensor Beacon
<b>Product SKU</b>	GAOTek-BB-126
<b>Product URL</b>	<a href="https://gaotek.com/product/gaotek-temperature-and-humidity-sensor-beacon/">https://gaotek.com/product/gaotek-temperature-and-humidity-sensor-beacon/</a>



# Product Specification

Version 1.1

## ***M1 Coin Beacon Tag***

The M1 is a coin tag with a low-energy Bluetooth 4.2(hardware compatible with bluetooth 5.0).

The device belongs to ultra-low-power ARM® chipset NORDIC® nRF52 series. It is a round shape device with a 26 mm diameter and its maximum thickness is 7.10 mm. It can be stuck on products or racks easily.

The beacon tags-based appliances are compatible with iOS 7.0+ and Android 4.3+ systems. It is compatible with Apple iBeacon and Google Eddystone (UID, URL, TLM).

The device comes with a superb quality replaceable CR2032 coin battery, which lifetime is about 15 months.

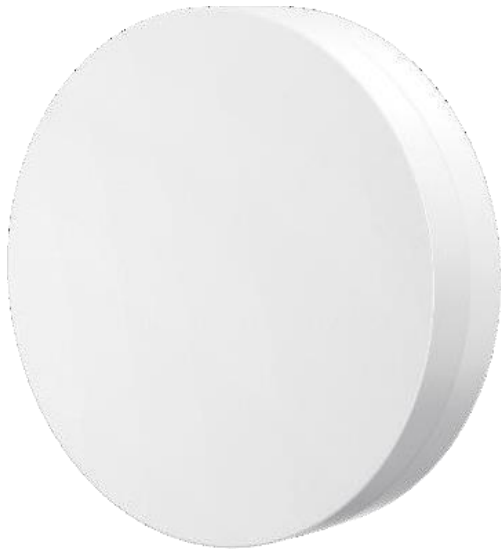
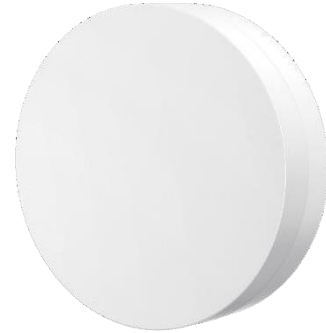

## TABLE OF CONTENTS

1. Product Brief .....	4
2. Application Scenarios .....	4
3. Specification.....	5
3.1 General specifications .....	5
3.2 Electronic specifications .....	6
3.2.1 Battery consumption.....	6
4. User guidance.....	7
4.1 How to wear/install M1?.....	7
4.2 How to replace battery on M1? .....	7
4.3 How to Power ON/OFF M1?.....	8
4.4 How to restore factory settings? .....	8
4.5 How to connect to APP and issue configurations?.....	9
5. General function.....	9
5.1 Multiple advertising type .....	9
5.2 Multiple advertising slot.....	11
5.3 Motion detection.....	11
5.4 Sensor sampling .....	12
5.5 Operating mode .....	12
5.5.1 Advertising mode.....	13
5.5.2 Power-off mode .....	13
5.5.3 Connected mode .....	13
5.5.4 Sleep mode .....	14
5.6 Monitoring duration statistics.....	14
5.7 Remote power off .....	14
5.8 Remote reboot .....	14
5.9 DFU update .....	14
5.10 Remote parameters configuration.....	15
6. Certifications .....	15
6.1 FCC certification .....	15
6.2 CE regulatory .....	16
7. Ordering information.....	17
7.1 Beacon ordering information.....	17

## 1. Product Brief

M1 Beacon is mainly used for assets tracking, personnel management and proximity marketing, etc. It can be used in many fields such as exhibitions, museums, hospitals, warehouses and so on. Its powerful RF performance enables the advertising distance to reach 40 meters in an open area. With an optional 3-axis accelerometer sensor, M1 can be used to record the movement information of assets and to analyze user behavior.



## 2. Application Scenarios



### *Scenario 1: M1 Beacon Tag for Your Asset Tracking System*

There is a 3-axis acceleration sensor (optional) on the M1 beacon tag, and the sensor data can be advertised via Bluetooth. In addition, we also provide SDK/API for your application development. So, you can integrate it into your system for asset tracking purposes. With sensor, M1 can help you accurately understand the condition of assets, visualize asset data, and save your asset management costs.

### *Scenario 2: M1 Beacon Tag for Your Proximity Marketing System*

M1 Beacon Tag can be set as an advertising mode. So, it also can be used for proximity marketing systems. You can create a more engaging in-store experience with M1. Clients can receive instant and limited offers as they walk inside the store or grocery shop. With these markers, customers can also



navigate through the store, and you can generate statistics on their behavior.

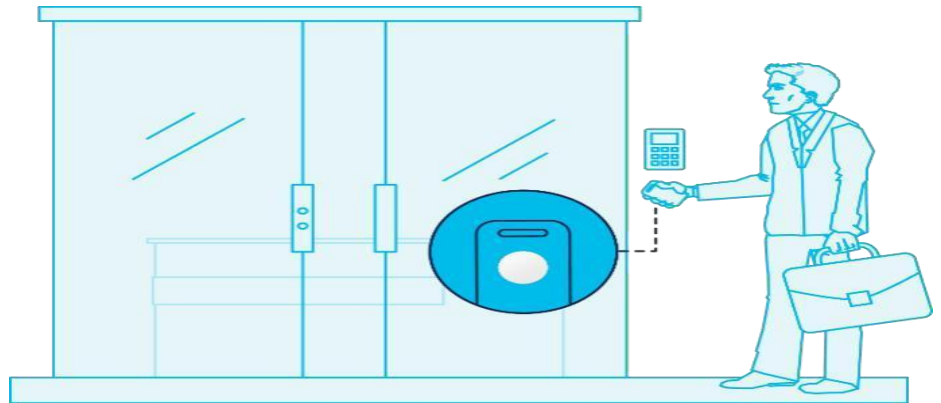

### 3. Specification

#### 3.1 General specifications

##### 3: Personnel management

The mini size makes it convenient for people to carry and easy to put into or stick on the ID badge holder. With real-time signal transmission, it allows location-based personnel management.

General specifications	
Main Chip	Nordic nRF52 series main chip
Bluetooth	Bluetooth 4.2(Hardware compatible with Bluetooth 5.0)
Dimension	26.0mm x 26.0mm x 7.1mm
Range	Up to 40 meters (in the open area and no obstacles)
Weight	5.4g (With battery)
Material	ABS+PC
Color	White
Installation	Sticker
LED	Single red LED (optional)
Sensor	3-axis accelerometer sensor (optional)
Operating temperature	General -20°C / + 60°C
Storage temperature	-20°C / + 70°C (without battery)
	10°C / + 25°C (with battery)
Humidity	0% ~ 95% (non-condensing)
Antenna Type	Ceramic antenna
Power supply	Replaceable 220mAh lithium coin CR2032 battery

Table 1: General specifications

## 3.2 Electronic specifications

### 3.2.1 Battery consumption

Here is described battery consumption in various situations which refer to different use cases. You can refer to the table below to create the use case and estimate battery lifetime.

3-axis Acc sensor sampling rate	SLOT1			Consumption (uA)	Life time*
	Advertising format	Tx power	Advertising interval		
10Hz	Device Info	0dBm	100ms	168.56	1.5 months
10Hz	Device Info	0dBm	500ms	64.84	3.8 months
10Hz	Device Info	0dBm	1000ms	55.09	4.5 months
10Hz	Device Info	4dBm	100ms	194.39	1.3 months
10Hz	Device Info	4dBm	500ms	68.71	3.6 months
10Hz	Device Info	4dBm	1000ms	54.18	4.5 months
10Hz	Device Info	-12dBm	100ms	153.36	1.6 months
10Hz	Device Info	-12dBm	500ms	57.41	4.3 months
10Hz	Device Info	-12dBm	1000ms	50.72	4.8 months
25Hz	Device Info	0dBm	1000ms	58.59	4.2 months
100Hz	Device Info	0dBm	1000ms	94.54	2.6 months

Table 2: Battery consumption in various situations

\* Above battery lifetime are estimated under continuous single advertising slot with 0dBm Tx power.

*Disclaimer: The contents of this battery estimation are for informational purposes only, and while effort has been made to ensure their accuracy, they are not to be construed as warranties or guarantees, express or implied, regarding the products or services described herein or their use or applicability.*



## 4. User guidance

### 4.1 How to wear/install M1?

Double sided tape

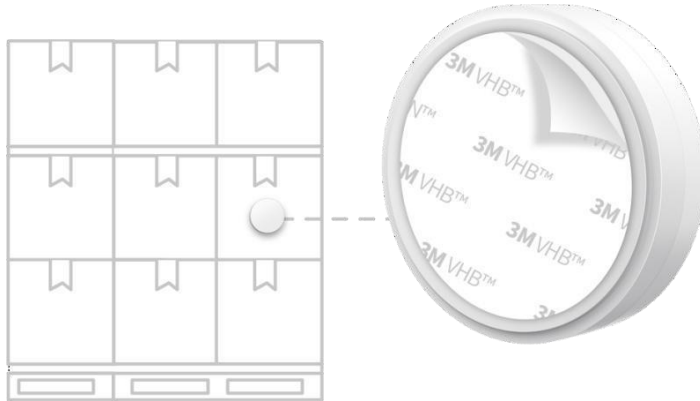

### 4.2 How to replace battery on M1?

Operation flow:

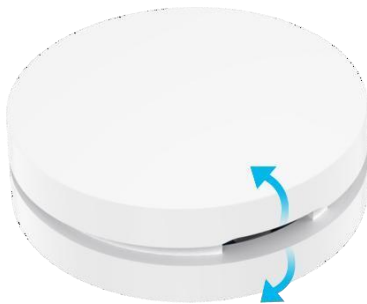

Step 1: Disassemble back cover through buckle which located in right bottom corner.

Step 2: Take out battery from the groove.





Step 3: Replace battery and assemble back cover. Please pay attention to the direction of back cover during assembling.

### 4.3 How to Power ON/OFF M1?

- Power ON: Remove the battery insulation sheet.
- Power OFF: You can power off the device by app.

### 4.4 How to restore factory settings?

There are two ways to restore factory settings.

- Independent mechanical button (Hardware reset): In power-off mode, long press inner mechanical button for 10s or more, then release button and single press button within 2s, device will proceed on factory reset.

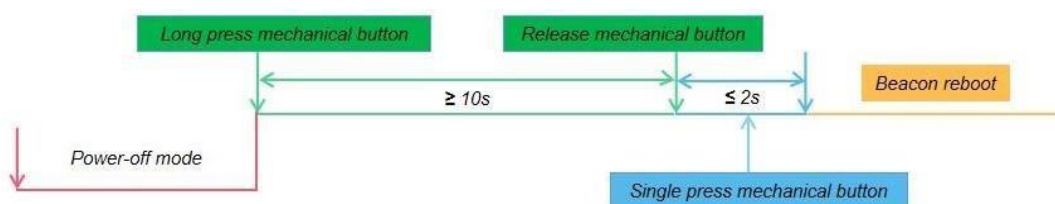

Figure 5: M1 Beacon Factory reset flow

- APP (Software reset\*): Remote factory reset through APP if M1 connected with phone APP.

\* Software reset will not reset connection password.

## 4.5 How to connect to APP and issue configurations?

Please download “BeaconX Pro” APP from play store directly. For more configuration details, please refer to document - “BeaconX Pro series Beacon User Manual”.

## 5. General function

### 5.1 Multiple advertising type

M1 supports multiple advertising types to comply with customers' requirements, such as primary Eddystone (UID/URL/TLM) and iBeacon protocol. What’s more, M1 also supports the MOKO customized protocol to display Beacon information and sensor data in real time, thus extending more application scenarios.

#### a) Eddystone-UID

Please refer to below standard Eddystone-UID format:

Byte offset	Field	Description
0	Service UUID	Value = 0xFE AA
2	Frame type	Value = 0x00
3	RSSI@0m	Calibrated Tx power at 0 m
4	Namespace ID	10 bytes Namespace ID
14	Instance ID	6 bytes Instance ID
20	RFU	2 bytes, reserved for future use, must be 0x00

#### b) Apple iBeacon

Please refer to below standard APPLE iBeacon format:

Byte offset	Field	Description
0	Company ID	Value = 0x4C 00 (Apple, Inc.)
2	iBeacon type	Value = 0x02 (Proximity Beacon)
3	iBeacon length	Value = 0x15 (Fixed)
4	UUID	16 bytes
20	Major	2 bytes
22	Minor	2 bytes
24	RSSI@1m	1-byte, Calibrated Tx power at 1 m; Range: -100~0dBm

c) 3-axis Acc sensor

MOKO customized advertising format for broadcasting 3-axis accelerometer sensor raw data, battery voltage etc. Please refer to below table for details.

Byte offset	Field	Description
0	Service UUID	Value = 0xFEAB
2	Frame type	Value = 0x60
3	Ranging data	1 byte, the Tx power in dBm emitted by the Beacon at custom distance (0m or 1m) Range: -100~0dBm
4	Advertising interval	1 byte, 100ms/bit; Range: 1~100
5	Sensor sampling rate	1 byte, 25Hz by default
6	Sensor full-scale	1 byte, ±2g by default
7	Trigger threshold	1 byte, the acceleration value to determine Beacon motion, 0.1g by default
8	Sensor data	6 bytes, the acceleration of X-axis, Y-axis, and Z-axis
14	Tx power	3 bytes (Tx power)
17	Battery voltage	2 bytes; 1mV/bit
19	RFU	1 byte, reserved for future use
20	MAC address	6 bytes

d) Device info

MOKO customized advertising format for broadcasting device status info. Please refer to the table below for details.

Byte offset	Field	Description
0	Service UUID	Value = 0xFEAB
2	Frame Type	Value = 0x40
3	Ranging data	1 byte, the Tx power in dBm emitted by the Beacon at custom distance (0m or 1m) Range: -100~0dBm
4	Advertising interval	1 byte, 100ms/bit; Range: 1~100
5	Battery voltage	2 bytes, 1mV/bit
7	Device property	Bit0-1, 00–need password; 11-no password is required.
		Bit2-7, reserved for future use
8	Device property	Bit0, 0-Unconnectable; 1-Connectable
		Bit1-7, reserved for future use
9	MAC Address	6 bytes

In this customized device info frame, there is a corresponding response package which contains the device name. (Need enable active scanning)

Byte offset	Field	Description
0	Device name	Maximum 22 bytes 20 characters and 2 bytes type & length

## 5.2 Multiple advertising slot

M1 can support up to 6 advertising slots and each slot configuration is independent. It means that the user can issue different configurations which include Tx power/ Adv interval/ Adv type and other parameters in each slot.

## 5.3 Motion detection

3-axis accelerometer sensor could be able to identify M1 motion status, and then switch into pre-configured advertising status or data. As well, user can also set motion detection trigger to achieve power saving mode. For more, please refer to “[chapter 5.5.2 motion trigger](#)”.

Regarding the 3-axis accelerometer sensor directions, you can refer to below hardware design and sensor specifications.

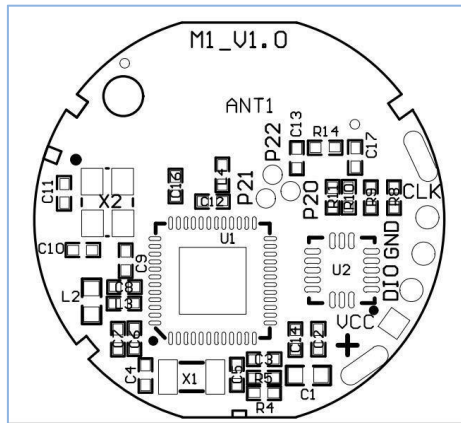

Figure 6: M1 Beacon PCBA design

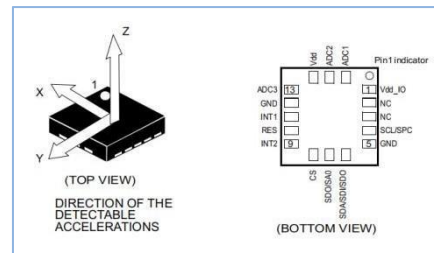

Figure 7: 3-axis accelerometer sensor specification

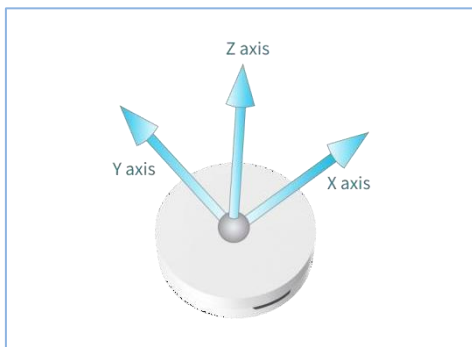

Figure 8: M1 accelerometer sensing direction

For M1 Beacon sensing direction with 3-axis accelerometer sensor, please refer to figure 8.

## 5.4 Sensor sampling

M1 can broadcast or notify 3-axis accelerometer sensor data in real time, so you can achieve the sensor sampling data through advertisement or Connection Notify property. It could be used for personnel tracking and falling detection.

Use case: Assuming that elderly individuals suffer accidental falls due to weakness or dizziness but cannot call for help immediately by themselves. But if wearing with M1 Beacon, it can broadcast real time 3-axis accelerometer sensor to cloud platform and recognize the fall behavior through algorithm, thus arranging the corresponding solutions.

## 5.5 Operating mode

Regarding M1 Beacon, there are several operating modes which reflect different features and states. Please refer to the operating mode flow.

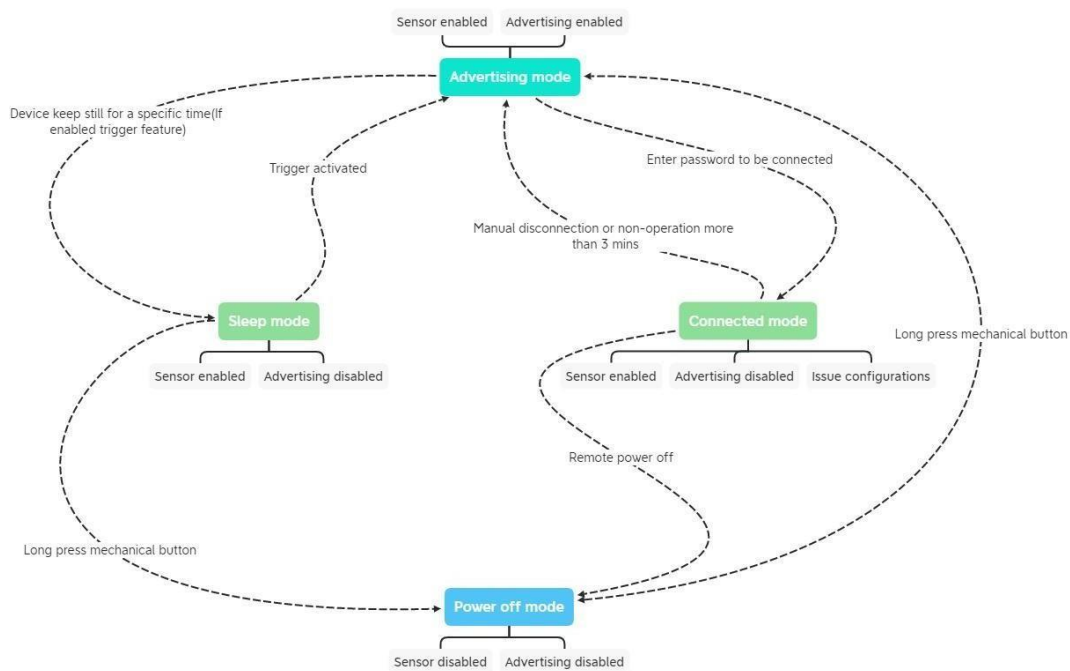

Figure 9: M1 Beacon Operating mode flow

### 5.5.1 Advertising mode

In advertising mode, M1 Beacon is broadcasting, sensor is working and can be scanned by central device.

### 5.5.2 Power-off mode

MCU will enter low power mode to wait for power on event, beyond that, all services which include advertisement, sensor, RTC etc. will be disabled.

### 5.5.3 Connected mode

In this mode, central devices (phone, gateway, or other master devices) is connected with M1 Beacon and can configure parameters through GATT services. When a connection is made to M1, the part will stay in a connected state until the master breaks the connection or is out of range. On disconnect, M1 returns to the broadcasting state unless a reset was initiated during the connection.

In connected mode, M1 Beacon will not broadcast but sensor will keep working still.

### 5.5.4 Sleep mode

In sleep mode, M1 is not connected with central device and not broadcasting as well, but sensor is working to wait for motion trigger or button trigger.

For instance, after the device keep in idle status for a specific time (default 30s and parameters configurable), then the device will stop broadcasting but keep sensor sampling working to maintain motion detection feature, that is also called power saving mode.

## 5.6 Monitoring duration statistics

In TLM frame, there are SEC\_CNT and ADV\_CNT values that represent working time and advertisement quantities since Beacon power-up or reboot. User can monitor duration statistics through this value.

Use case - Products promotion

When customers pick up specific goods, motion detection in M1 Beacon will be triggered. The merchant can calculate the trigger frequency by combining the motion trigger times and total monitoring duration, thus providing the customer preference analysis.

## 5.7 Remote power off

Device firmware can support remote power off feature. This function should be realized through an APP.

## 5.8 Remote reboot

Device firmware can support remote reboot feature. This function should be realized through an APP.



## 5.9 Remote parameters configuration

The device supports various configurable parameters, and you can issue the parameters below through “Beacon Pro” APP directly.

- Advertising format and data
- Advertising slot
- Beacon name
- Tx power
- Advertising interval
- Connection password
- Trigger options.
- Sensor parameters

### CAUTIONS

Any changes or modifications not expressly approved by the party responsible for compliance could break the user's authority to operate the equipment.

NOTE: This equipment has been tested and found to comply with the limits for a Class B digital device, pursuant to Part 15 of the FCC Rules. These limits are designed to provide reasonable protection against harmful interference in a residential installation. This equipment generates, uses and can radiate radio frequency energy and, if not installed and used in accordance with the instructions, may cause harmful interference to radio communications.

However, there is no guarantee that interference will not occur in a particular installation.

If this equipment does cause harmful interference to radio or television reception, which can be determined by turning the equipment off and on, the user is encouraged to try to correct the interference by one or more of the following measures:

- Reorient or relocate the receiving antenna.
- Increase the separation between the equipment and receiver.
- Connect the equipment into an outlet on a circuit different from that to which the receiver is connected.
- Consult the dealer or an experienced radio/TV technician for help.

The device has been evaluated to meet general RF exposure requirement. The device can be used in

portable exposure condition without restriction. **FCC**

**ID: 2A094-M1**

## 5.10 CE regulatory

### CE-RED

Reference standards used for presumption of conformity:

Article number	Requirement	Reference standard(s)
3.1(a)	Health & Safety	EN 62479:2010 EN IEC 62368-1:2020+A11:2020
3.1(b)	Protection requirements – EMC compatibility	EN 301489-1 V2.2.3 (2019-11) EN 301489-17 V3.2.4 (2020-09) EN 55032:2015+A1:2020 EN 55035:2017+A11:2020 EN IEC 61000-3-2:2019+A1:2021 EN IEC 61000-3-3:2013+A1:2019
3.2	Means of the efficient use of the radio frequency spectrum (ERM)	EN 300 328 V2.2.2 (2019-07)

## REACH

Two hundred and nineteen (219) substances in the Candidate List of Substances of Very High Concern (SVHC) for authorization published by European Chemicals Agency (ECHA) on - (EC) No 1907/2006 concerning the REACH.

we confirm that:

1. None of our products are intended to release any hazardous chemicals.
2. We will take appropriate action in response to any two business risks arising through the supplier's failure to co-operate and support us in this project.
3. We will do our utmost to ensure that continuity of supply of our products will not be adversely affected by issues arising from the REACH regulations.



Contact us: [sales@gaotek.com](mailto:sales@gaotek.com)