

Product Name	GAOTek LoRa Gateway
Product SKU	GAOTek-LHR-160
Product URL	https://gaotek.com/product/gaotek-lora-gateway/



CONTENT

1 PRODUCT INTRODUCTION5

1.1 GENERAL INTRODUCTION.....5

1.2 TYPICAL APPLICATION6

1.3 SAFETY INTRODUCTION7

1.4 FEATURES9

1.5 TECHNICAL PARAMETERS.....10

2 HARDWARE INTRODUCTION13

2.1 LED INDICATOR.....13

2.2 INTERFACE DEFINITION.....14

2.3 ETHERNET PORT14

2.4 SIM CARD SLOT14

2.5 POWER SWITCH/UPGRADING SWITCH16

2.6 USB PORT16

3 GATEWAY MOUNTING.....17

3.1 DIN-RAIL MOUNTING.....17

4 PARAMETER CONFIGURATION17

4.1 PREPARATION FOR CONFIGURING THE GATEWAY17

 4.1.1 INSTALL USB DRIVER17

 4.1.2 SEARCH FOR PORT NUMBER18

 4.1.3 LOGIN TO CONFIGURATION SOFTWARE.....19

4.2 BASIC SETTINGS20

4.3 ETHERNET & CELLULAR NETWORK CONFIGURATION22

4.4 CLOUD PLATFORM.....23



4.5 WIRELESS NODE CONFIGURATION.....30

4.6 WIRELESS NODE MANAGEMENT.....33

4.7 HISTORICAL RECORD35

4.8 ALARM RECORD35

5 SMS COMMAND.....37

6 COMMUNICATION PROTOCOL39

6.1 MODBUS RTU PROTOCOL39

6.2 MODBUS TCP PROTOCOL.....43

6.3 MQTT PROTOCOL48

7 FIRMWARE UPGRADING.....48

8 WARRANTY TERM48

9 APPENDIX A SMS COMMAND LIST.....49

10 APPENDIX B REGISTER ADDRESS53

11 APPENDIX C MQTT APPLICATION60

12 APPENDIX D LORA NODE INTRODUCTION.....68

WT100 (RS485 TRANSPARENT TRANSMISSION NODE).....68

WT101(4 DIGITAL INPUT DATA COLLECTION NODE).....70

WT102 (2 RELAY OUTPUT CONTROL NODE).....71

WT103 (AM2301 TEMPERATURE & HUMIDITY DATA COLLECTION NODE)73

WT104 (AM2401 TEMPERATURE & HUMIDITY DATA COLLECTION NODE)74

WT105 (DS18B20 TEMPERATURE DATA COLLECTION NODE).....48

WT106 (PT100 TEMPERATURE DATA COLLECTION NODE).....51

WT107 (MULTIPLE ENVIRONMENTAL DATA COLLECTION NODE)52

WT108 (SOIL PH VALUE COLLECTION NODE)53

WT109 (SOIL EC DATA COLLECTION NODE).....54



WT110 (SOIL MOISTURE CONTENT DATA COLLECTION NODE)	56
WT111 (MULTIPLE-PARAMETER COLLECTION NODE)	58

1 Product Introduction

1.1 General Introduction

Wireless Data Acquisition System S281 is based on LoRa RF technology. It's mainly used for collecting multiple environmental data distributed in different long-range areas and transparent data transmission from device to cloud. With LoRa modulation technology, it's capable of realizing multiple IO device monitoring, collecting data of temperature & humidity, light intensity, CO2, wind direction & speed and soil conditions.

LoRa communication range is up to 2KM. Built-in LoRa chip SX1278 and GSM/GPRS/3G/4G/RJ45 module work together to achieve remote monitoring and control by sending sensor, PLC, smart meter and other device data to cloud or mobile phone via SMS/2G/3G/4G/Ethernet. Huge field wiring cost will be saved.

This wireless data acquisition system comprised of 2 parts, LoRa Gateway S281 and LoRa Nodes. Nodes connect sensor, PLC and other devices. The collected data is sent to gateway. Mutual communication between PLC and cloud is done through wireless RF technology. Alarm threshold can be set in gateway so that alarm events can be recorded.

1.2 Typical Application

- Smart greenhouse data collection and monitoring
- Smart crop land data collection and monitoring
- Smart Breeding Temp& Humi data collection and monitoring
- Smart factory temp & humi data collection and monitoring
- ATM, POS, PLC and DAQ device data transmission
- Smart grid data transmission
- Smart transportation data transmission
- Industrial automation data transmission
- Environmental protection data transmission
- Weather station data collection and monitoring
- Agriculture, Aquaculture and coal mine site data transmission
- Smart agriculture, smart fire protection, smart city, smart building, etc
- Other distributed site data collection and monitoring

1.3 Safety Introduction



Safety Notice:

Please don't use this device in the place where mobile phone is prohibited.



Wireless Interference

Please avoid wireless interference to impact GSM/GPRS/3G/4G network.



- 1x MINI USB cable



- 1x LoRa Antenna



- 1x 2G/3G/4G SMA Cellular Network Antenna (AT-25)



- 1x Power Adaptor (12VDC/2A)



- 1x User Manual (Soft Copy)

Note: If any of the above parts are missing, please contact BLIIoT sales team.

Optional Part (Must order it separately)

- 35mm DIN Rail Mounting Bracket

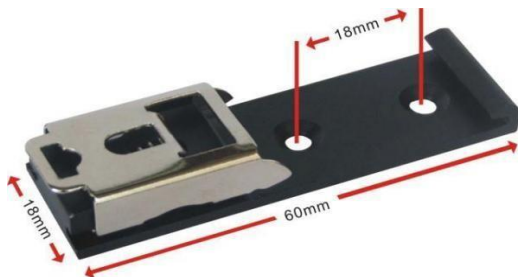

1.4 Features

- Embedded ARM®Cortex™-M 32-bit RISC core real-time operation system, software and hardware watchdog to avoid false deadlock.
- Support 9~36VDC power supply with reverse wiring protection design
- Modular design, only communication module changes to upgrade GSM/3G/4G network
- Support remote device restart and configuration with SMS.
- Device parameters can be set easily with local configuration software, SMS, and APP
- Support MQTT, Modbus TCP, Modbus RTU, transparent transmission and custom handshake protocol to actively connect server & automatically re-connect server if network disconnected.
- Support Alibaba Cloud, HUAWEI Cloud, King Pigeon Cloud and other clouds with standard Modbus MQTT protocols.
- Ethernet port has transformer isolator with 2KV electromagnetic isolation.
- Support long range wireless data transmission with data collection and device control nodes.
- Support multiple environmental data collection, max 12 types of different nodes can collect data simultaneously.
- Automatic offline re-connection function ensure nodes and gateway are connected permanently.
- Support real-time monitoring node battery usage to avoid device data loss.

1.5 Technical Parameters

Item	Parameter	Description
Power Supply	Power Voltage	9~36V DC
	Power Consumption	Normal: 130mA@12V, Max 150mA@12V
	Protection	Reverse wiring protection, ESD air: 15KV, surge: 4KV
	Backup Battery	3.7V/900mAh
USB	USB	1 x mini USB
Ethernet Port	Spec	1 x RJ45, 10/100Mbps
	Protection	ESD contact: 8KV, surge: 4KV (10/1000us)
	Protocol	Modbus RTU, Modbus TCP, MQTT
LoRa Parameter	Communication frequency	402MHz-500MHz, optional 860-930MHz
	City communication range	1km
	Visible communication range	2km
	Transmitting power	<24dBm
	Receiving sensitivity	<-120dBm
	Air communication speed	1.0Kbps
	2G	GSM/EDGE: 850,900,1800,1900MHz
	3G	GSM/EDGE: 850,900,1800,1900MHz UMTS: 850,900,2100MHz
	4G (E version)	GSM/EDGE: 900,1800MHz WCDMA: B1,B5,B8 FDD: B1,B3,B5,B7,B8,B20 TDD: B38,B40,B41
	4G (AU version)	GSM/EDGE: 850,900,1800MHz WCDMA: B1,B2,B5,B8 FDD: B1,B2,B3,B4,B5,B7,B8,B28 TDD: B40

Cellular Network	4G (A version)	WCDMA: B2,B4,B5 FDD: B2,B4,B12
	4G (V version)	FDD: B4,B13
	4G (J version)	WCDMA: B1,B3,B8,B18,B19, B26 FDD: B2,B4,B12 TDD: B41
	4G (CE version)	GSM/EDGE: 900,1800MHz WCDMA: B1,B8 TD-SCDMA: B34,B39 FDD: B1,B3,B8 TDD: B38,B39,B40,B41
	Protocol	Modbus RTU, Modbus TCP, MQTT
	SIM/UIM Card slot	Standard flip cover, support 1.8V/3V SIM/UIM card, built-in 15KV ESD protection
Software Parameter	Network Protocol	IPV4, TCP/UDP, DHCP, DNS, Modbus RTU, Modbus TCP, MQTT
	Indicator	Cellular Network Signal, Status, Ethernet and LoRa Radio Frequency

	User Configuration	PC software configuration, support WIN XP, WIN 7, WIN 8 and WIN 10
	Node QTY	Support max 50 nodes
	Node Type	Suport WT100-WT111, max 12 different types
	Data Transmission	Support Transparent Transmission
	SMS Command	Support SMS Commands
	Login Package	Support custom login package
	Heartbeat Package	Support custom heartbeat package
	Storage	Max 2000 historical records & 500 alarm records
Certification	MTBF	≥100,000 hours
	EMC	EN 55022: 2006/A1: 2007 (CE &RE) Class B
		IEC 61000-4-2 (ESD) Level 4
		IEC 61000-4-3 (RS) Level 4
		IEC 61000-4-4 (EFT) Level 4
		IEC 61000-4-5 (Surge)Level 3
		IEC 61000-4-6 (CS)Level 4
	IEC 61000-4-8 (M/S) Level 4	
Others	CE, FCC, ROHS, 3C	
Environment	Working Environment	-45~85°C, 5~95%RH
	Storage Environment	-45~105°C, 5~95%RH
Others	Case Material	Metal
	Size	88mm×75mm×30mm (L*W*H)
	Protection Grade	IP30
	Net Weight	235g
	Mounting	Wall-Mounting, DIN Rail Mounting

2 Hardware Introduction

2.1 LED Indicator

LED Indicator				
No.	Item	Color	Status	Description
1		Red	Fast flickering	2G: No signal (0.8s off, 0.2s on) 3G/4G: No signal (1s off, 0.8s on)
			Slow	2G: Normal (2s off, 0.2s on)

2	Status	Red	Stead On	External Power Supply is normal
			Off	External power supply is lost
3	Ethernet	Red	Flickering	Ethernet port has data transmission
			Off	Ethernet port has no data transmission
4	RF	Red	Flickering	LoRa RF has data transmission
			Off	LoRa RF has no data transmission

2.2 Interface Definition

Power Supply



Power Supply		
No.	Item	Description
1	In+	Positive Pole of Power Input
2	In-	Negative Pole of Power Input

2.3 Ethernet Port

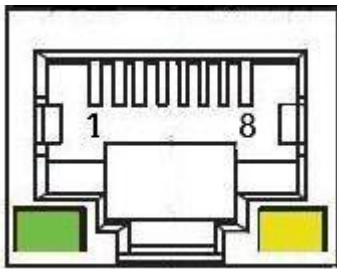

Ethernet Port Introduction			
No.	Color	Item	Description
1	Orange white	TX+	Positive of Transmitting
2	Orange	TX-	Negative of Transmitting
3	Green white	RX+	Positive of Receiving
4	Blue	Data+	Positive of two-way data communication
5	Blue white	Data-	Negative of two-way data communication
6	Green	RX-	Negative of Receiving
7	Brown white	Data+	Positive of two-way data communication
8	Brown	Data-	Negative of two-way data communication

2.4 SIM Card Slot

S281 support 1.8V/3V SIM card



2.5 Power Switch/Upgrading Switch

Make sure device is powered off before inserting SIM card. Follow Open direction to push SIM card slot and then place the card into it.

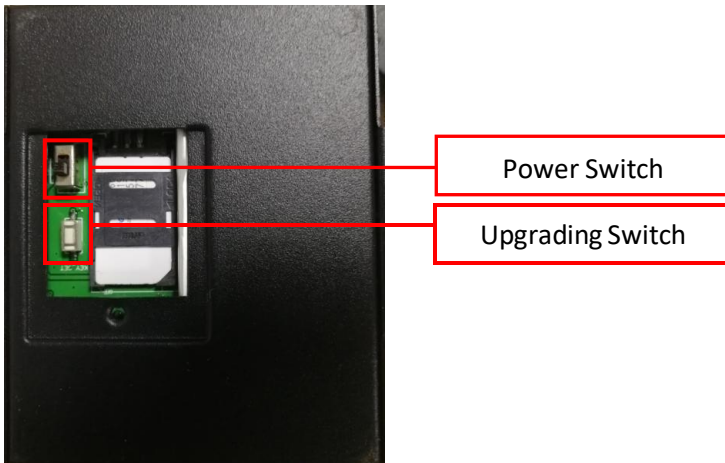

2.6 USB Port

mini USB port is used to connect S281 to PC for configuring parameters and upgrading firmware



3 Gateway Mounting

This gateway supports horizontal placement on the table, wall-mounting and DIN Rail mounting.

3.1 DIN-Rail Mounting

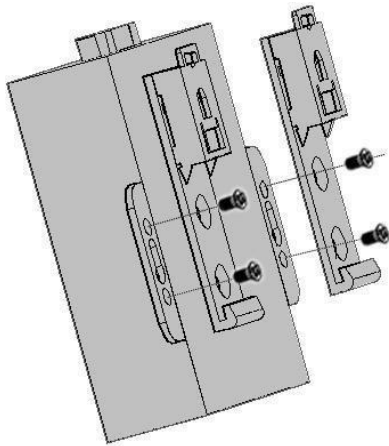

Assembling clip buckle

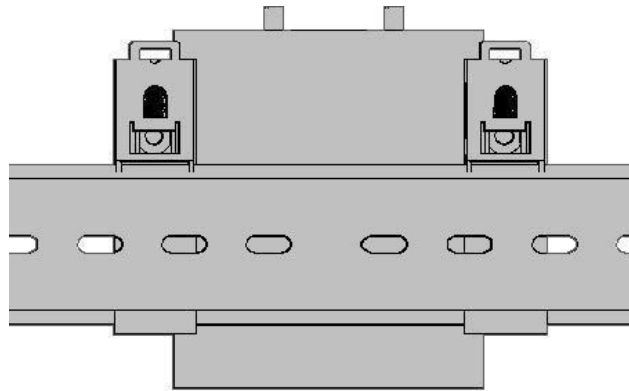

Mounting on DIN Rail

4 Parameter Configuration

S281 configuration software has user-friendly interface. Just connect S281 Gateway (hereafter referred to as Gateway) to PC with USB cable to set parameters, export files and upgrade firmware.

4.1 Preparation for Configuring the Gateway

4.1.1 Install USB Driver

Skip this process if USB driver is installed already.

Download S281 configuration software and USB driver from BLIIoT website: www.iot-solution.com If any downloading issue, please contact BLIIoT sales team

4.1.2 Search for Port Number

Right click My Computer, then click Property-Device Manager-Port, if it's connected normally and USB driver is installed successfully, it will show as below:(Gateway port number is COM5)

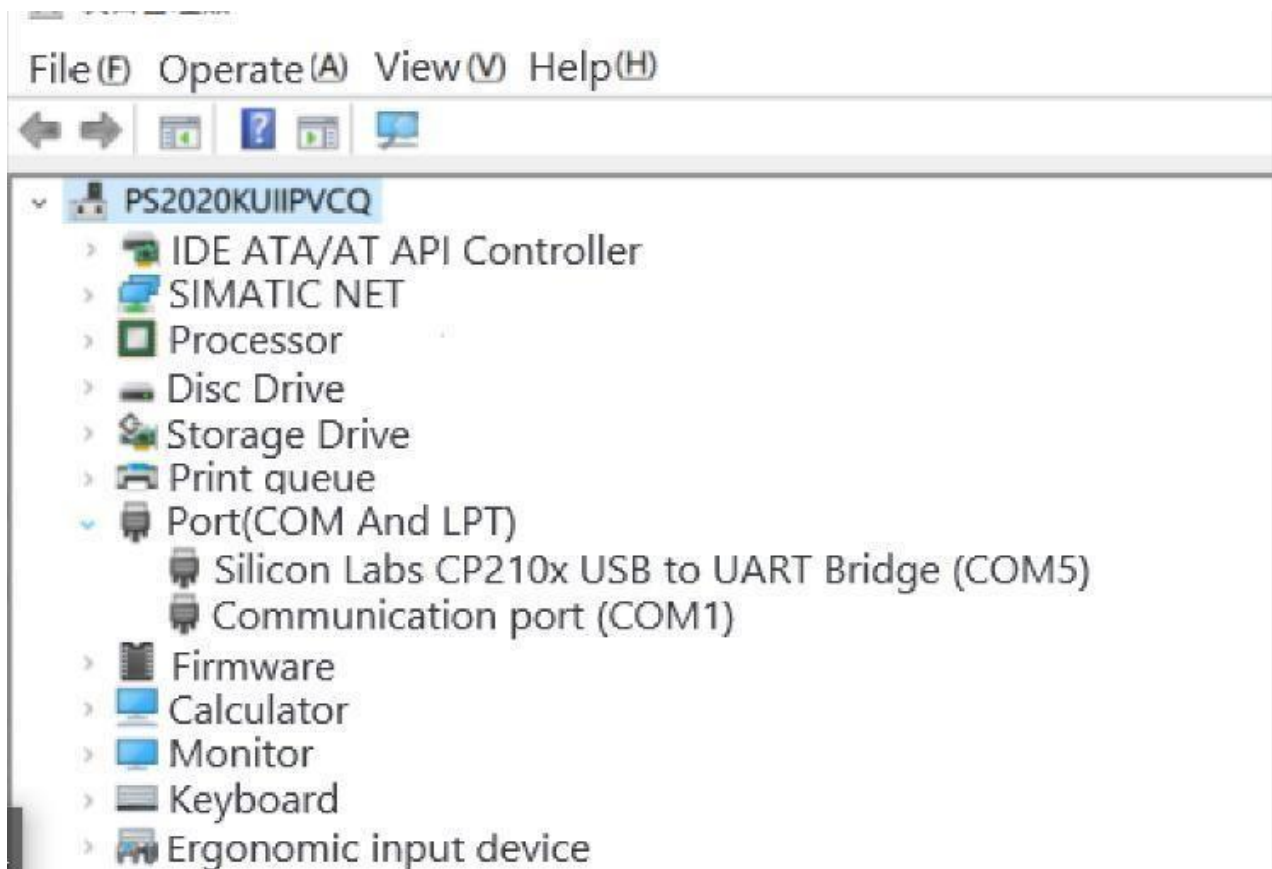

4.1.3 Login to Configuration Software

Click  BL280 Configuration Software to execute it and enter below page:



Select connected serial port , input password (default is 1234 and it's filled automatically), click login to enter below main page. If login is not successful, please check USB connection, password and port number.

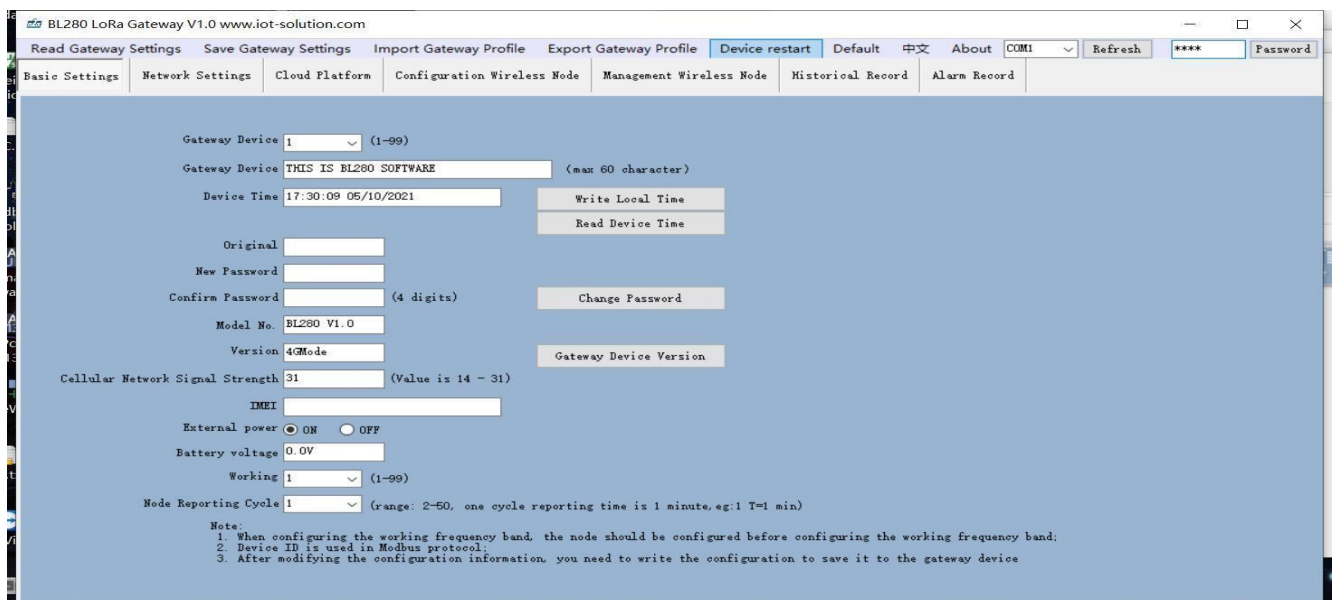

Note:

1. When configuring the working frequency band, the node should be configured before configuring the working frequency band;
2. Device ID is used in Modbus protocol;
3. After modifying the configuration information, you need to write the configuration to save it to the gateway device

4.2 Basic Settings

In this page, user can quickly configure and get basic device information, including device model, version, password, time, ID, description, etc

The screenshot shows the 'Basic Settings' page for the BL280 LoRa Gateway V1.0. The interface includes a navigation menu at the top with options like 'Read Gateway Settings', 'Save Gateway Settings', 'Import Gateway Profile', 'Export Gateway Profile', 'Device restart', 'Default', '中文', 'About', 'COM1', 'Refresh', and a password field. The main content area contains several configuration fields and buttons:

- Gateway Device ID:** A dropdown menu set to '1' (range 1-99).
- Gateway Device Name:** A text input field containing 'THIS IS BL280 SOFTWARE' (max 60 characters).
- Device Time:** A text input field showing '17:30:09 05/10/2021' with buttons for 'Write Local Time' and 'Read Device Time'.
- Password:** Fields for 'Original', 'New Password', and 'Confirm Password' (4 digits) with a 'Change Password' button.
- Model No.:** A text input field showing 'BL280 V1.0'.
- Version:** A text input field showing '4GMode' with a 'Gateway Device Version' button.
- Cellular Network Signal Strength:** A text input field showing '31' (value range 14-31).
- IMEI:** A text input field.
- External power:** Radio buttons for 'ON' and 'OFF'.
- Battery voltage:** A text input field showing '0.0V'.
- Working:** A dropdown menu set to '1' (range 1-99).
- Node Reporting Cycle:** A dropdown menu set to '1' (range 2-50, one cycle reporting time is 1 minute, eg: 1 T=1 min).

Note:

- When configuring the working frequency band, the node should be configured before configuring the working frequency band;
- Device ID is used in Modbus protocol;
- After modifying the configuration information, you need to write the configuration to save it to the gateway device

Basic Information		
Item	Description	Default
Device ID	Range: 1~247, device ID is used to identify the gateway in monitoring center	1
Gateway Device	Input custom device name	Null
Read Device Time	Read current gateway time	--
Write Local Time	Write local compute time to gateway	--
Change Password	Click it to change password	--
Original Password	Original device password	Null
New Password	Input new password	Null
Confirm Password	Confirm new password	Null
Gateway Device Version	Click it to read device model, version, IMEI, cellular network signal strength	--

Model No.	Device Model	--
Version	Firmware version	--
IMEI	Unique IMEI number of the communication module	--
Battery Voltage	Backup battery voltage	--
Cellular Network Signal Strength	Cellular network signal strength, range 0-31, If the value is 0, please make sure SIM card is inserted properly and charged.	--
Working Frequency Range	Range: 1~99, gateway and node must be in the same communication frequency range.	1
Node Reporting Cycle	Node data uploading cycle, Range: 2~50(minute)	1

4.3 Ethernet & Cellular Network Configuration

Set Ethernet and cellular network parameter in below page

The screenshot displays the web interface for BL280 LoRa Gateway V1.0. The browser address bar shows 'BL280 LoRa Gateway V1.0 www.iot-solution.com'. The interface includes a navigation menu with options like 'Read Gateway Settings', 'Save Gateway Settings', 'Import Gateway Profile', 'Export Gateway Profile', 'Device restart', 'Default', '中文', 'About', 'COM1', 'Refresh', and 'Password'. The main content area is divided into two sections: 'Cellular Network Configuration' and 'Ethernet Setting'.

Cellular Network Configuration:

- Access Point:
- User Name:
- Password:
- Note: Chinese mainland does not need to configure this parameter.

Ethernet Setting:

- IP Type: Static (dropdown)
- Device IP: 192.168.1.249
- Local Listening: 502
- Subnet Mask: 255.255.255.0
- Gateway: 192.168.1.1
- DNS IP1: 8.8.8.8
- DNS IP2: 2.3.3.3

Network Configuration		
Item	Description	Default
APN (Access Point Name)	Mobile service provider APN access point (not necessary in China)	Null
User Name	APN user name (not necessary in China)	Null
Password	APN password (not necessary in China)	Null
IP Mode	Set static / dynamic IP	Static
Device IP	Gateway S281 IP Address	Null
Local Listening Port	Device port number as TCP/UDP server, can be custom, range 0-65536	Null
Subnet Mask	Current Subnet Mask	Null

Router IP	Current Router IP Address	Null
DNS server 1	Current DNS server 1 IP address	Null
DNS server 2	Current DNS server 2 IP address	Null

Note: this gateway can be used as TCP server and TCP client.

4.4 Cloud Platform

This page is to configure the parameters for connecting device to internet. With rich automatic handshake login packages, custom heartbeat packages and logout function, it can be connected to

monitoring software or cloud for two-way communication through GPRS/3G/4G and Ethernet.

Below are the options:

- 1) Modbus RTU Protocol, i.e. Modbus RTU over TCP, transfer Modbus RTU protocol in TCP link to realize two-way communication between gateway and host computer. For example, input cloud platform WWW.MY-M2M.COM, Domain name: modbus.dtuip.com, port: 6651
- 2) Modbus TCP protocol, i.e.add TCP to the beginning and end of standard RTU protocol message to realize two-way communication between gateway and host computer. For example, input cloud platform WWW.MY-M2M.COM, Domain name: mbtcp.dtuip.com, port: 6655
- 3) MQTT protocol, i.e. execute MQTT protocol in TCP link to realize two-way communication between gateway and host computer. The advantage of MQTT is data will be saved in cache if network is lost and re-transmitted once network recovers. For example, input cloud platform: WWW.MY-M2M.COM, Domain name: mqtt.dtuip.com, port: 1883

The screenshot shows the web interface for the BL280 LoRa Gateway V1.0. The 'Cloud Platform' tab is selected. Under 'Priority', 'Both of them' is chosen. The 'Connect other IOT server' button is highlighted. Server 1 is configured with the MQTT Protocol. The 'Communication Protocol' is set to 'MQTT Protocol'. The 'Login Message', 'Login ACK Message', 'Logout Message', 'Heartbeat Message', and 'Heartbeat ACK' are all set to 'ASCII'. The 'Login Message Strategy' is 'Send Once When Login Server'. The 'Target Services' for Server 1 are: IP/DNS 'mqtt.dtuip.com', Listen Port '1883', Protocol 'TCP', Heartbeat Interval '60(s)', Idle Offline Reconnection '60(s)', and No Response Resend Time '3'. The 'MQTT Protocol Settings' include: 'Subscribe Topic' '/+', 'Publish Topic' (empty), 'MQTT Client ID' (empty), 'MQTT User Name' 'MQTT', 'MQTT Password' 'MQTTPW', 'Automatic data upload cycle' '60(s)', and 'MQTT Data retransmission' 'DISABLE'. A note at the bottom right states: 'Note: when priority is selected at the same time, server 1 is connected by Ethernet, Server 2 is connected by cellular network, and mqtt protocol is only implemented by server 1.'

Communication Protocol @ Cloud Platform

Item	Description	Default
Priority	Set network priority, include Ethernet first, Cellular network first and both of them	Ethernet first

King Pigeon Cloud V2.0 (Modbus)	Set parameters for server 1 to connect King Pigeon cloud V2.0 (Modbus RTU Over TCP)	--
King Pigeon Cloud V2.0 (MQTT)	Set parameters for server 1 to connect King Pigeon cloud V2.0 (MQTT)	--
King Pigeon Cloud V3.0	Set parameters for server 1 to connect King Pigeon cloud V3.0 (Modbus RTU Over TCP)	--
Alibaba Cloud	Set parameters for server 1 to connect Alibaba Cloud(via private key)	--
HUAWEI Cloud	Set parameters for server 1 to connect HUAWEI Cloud(via private key)	--
Other Cloud Platform	Custom parameters for connecting to required servers	--

Note:

(1) Priority setting, if Ethernet first is selected, it will use Ethernet for connecting server 1. If cellular network first is selected, cellular network will be used for connecting server 1. If both network is selected, server 2 will started, device supports both servers. Ethernet and cellular network will be used at the same time.

(2) If connecting device to King Pigeon cloud V2.0 or V3.0, please contact BLIIoT sales team to get device serial number and put it in login package box

Login Package@Cloud Platform		
Item	Description	Default
Communication protocol	Select communication protocol, include Prohibited, Modbus RTU Over TCP, MQTT	Disabled
Login Message	Server side login handshake message	Null
Login ACK Message	If Login Acknowledgement Message is input, server must give response within 10s. Otherwise device will continue to send login message. Once login message sending times reach limit, device will be offline and then re-connect immediately. After device go offline 3 times, it will re-connect to service after the set interval	Null
Logout Message	If it's set and server sends logout message, device will go offline	Null
Heartbeat Message	If it's set, device will send heartbeat message frequently according to the set interval	Null
Heartbeat ACK Message	If it's set, server will send Heartbeat Acknowledge Message within 6s. Otherwise it will be timeout and device will send heartbeat message for reconnecting. Once the re-connecting times reach limit, device will go offline and reconnect immediately. After device goes offline 3 times, it will re-connect after the set interval	Null
Login Message Strategy	Login Message Sending Rule	Send once login to server

Protocol	Choose TCP, UDP	TCP
Heartbeat Interval	Heartbeat message sending interval, unit: second	60
Idle Offline Re-connection	Once device is connected to server but no response is received from server within certain period, device will disconnect with server and re-connect after the set duration. Range: 0-65535, unit: second	120
No Response Resend Time	Set the times of device re-connecting to server if it goes offline. Range: 1-9. Unit: times. If it's not connected to server after the reconnecting times reaches limit, cellular network will automatically restart.	3

Server Setting@ Cloud Platform

Item	Description	Default
Server IP/ Domain Name	Target Server IP or Domain Name	Null
Server Port	Target Server Port	Null

MQTT Setting@Cloud Platform

Item	Description	Default
Subscription Topic	Subscription topic when device receives control data	Null
Publish Topic	Topic of device publishing messages	Null

MQTT Device ID	Device serial number, unique identification	Null
MQTT User Name	User Name of device to publish topic in proxy server	Null
MQTT Password	Password of device to publish topic in proxy server	Null
Data Uploading Interval	Device data uploading interval, minimum 10s	60s
MQTT Data Re-transmission	If it's enabled, device data will be saved in cached if network disconnect and re-transmitted once network recovers	Disabled

Note: MQTT protocol can only be realized in Server 1

S281 only support connecting to Alibaba cloud and HUAWEI Cloud without certificate

Alibaba Cloud Parameter Setting@Cloud Platform		
Item	Description	Default
Communication Protocol	Select Enable or Disable	Disabled
ProductKey	Set the same ProductKey as Alibaba cloud (IOT platform—device—click DeviceSecret to view it)	Null
DeviceName	Set the same DeviceName as Alibaba cloud (IOT platform—device—click DeviceSecret to view it)	Null
DeviceSecret	Set the same DeviceSecret as Alibaba Cloud (IOT platform—device—click DeviceSecret to view it)	Null
Region	Select Alibaba Cloud server location, default is China East 2 (Shanghai)	Null
Uploading Interval	Set interval of uploading device data to cloud, minimum 10s	60s

Note: Alibaba cloud IOT model is under development. Thus datapoint must be added one by one. When adding datapoint, make sure the identification mark is the same as the MQTT mark in configuration software. For example, if MQTT identification mark of node WT107 ID 1 temperature value is TEMP1, set the same datapoint mark TEMP1 in Alibaba cloud. For other marks refer to: [Appendix C MQTT Application](#)

HUAWEI Cloud Parameter Setting@Cloud Platform		
Item	Description	Default

Communication Protocol	Select Enable or Disable	Disable
DeviceID	Set the same Device ID as HUAWEI Cloud (IOT Platform-device-device ID)	Null
DeviceSecret	Set the same DeviceSecret as HUAWEI Cloud when creating devices	Null
Service ID	Set the same Service ID as HUAWEI Cloud (IOT Platform-Product-Service ID)	Null
Server IP/Domain Name	Input IP of connecting HUAWEI cloud via MQTT (Enter console-click overview to get server IP)	Null
Server Port	HUAWEI IOT platform port, fixed 1883	1883
Data Uploading Interval	Interval of data uploading to cloud, minimum 10s	60s

Note: Please make sure the datapoint identification mark in HUAWEI Cloud is the same as the MQTT mark in configuration software. For example, if MQTT mark of node WT107 ID 1 temperature value is TEMP1, then set TEMP1 in HUAWEI cloud as datapoint mark. For other marks refer to [Appendix C MQTT Application](#)

4.5 Wireless Node Configuration

Below page is to configure node parameters. Before configuration, the node must be powered on. Make sure node and gateway are in the same network, i.e. frequency range: default is 1. Once node is started, it will be shown on the right. Each node has 5 minutes to be configured. If newly added node is not listed on the right, please restart it. Each node has its own unique MAC address. Node can be found by its MAC address. There are 12 types of nodes, WT100-WT111. WT100 is transparent transmission node and the rest are data collection nodes. Below is the example of configuring WT107 and WT100.

The screenshot shows the web interface for configuring wireless nodes. The main navigation tabs include Basic Settings, Network Settings, Cloud Platform, Configuration Wireless Node (selected), Management Wireless Node, Historical Record, and Alarm Record. The Configuration Wireless Node page is divided into three main sections:

- Slave Settings:** This section allows configuring various sensors. It includes a dropdown for Slave No, a text field for Name, and a dropdown for Slave Model. Below these are seven rows of sensor settings, each with a Channel Name dropdown, a Maximum value dropdown, and a Minimum value dropdown. The sensors are: Air Temperature (°C), Air Humidity (%RH), Illuminance (Lx), CO2 value (ppm), Air Quality (ppb), Soil (°C), and Soil Moisture (%RH). A "Slave Setting" button is located at the bottom right of this section.
- Slave WT100 Settings:** This section is for configuring WT100 nodes. It includes a Slave No dropdown, a Slave Model dropdown (set to WT100), and four dropdowns for Baudrate, Data Bit, Parity, and Stop Bit. A "Slave WT100" button is at the bottom right.
- Configurable Slave:** This section contains a table listing nodes that are ready for configuration. The table has columns for Slave Type, NO., Slave Function, MAC, and Status.

Slave Type	NO.	Slave Function	MAC	Status
WT102	3	Two 90 Control Outputs	Q4BE12	Not Configured
WT107	8	Multi Data Acquisition	3BS901	Not Configured
WT108	2	Soil PH Collection	1B2931	Not Configured
WT100	2	Transparent Transmission	3BS191	Not Configured

A note at the bottom right of the interface provides the following instructions:

1. Turn on the wireless gateway;
2. Turn on the wireless nodes in turn;
3. After the node is turned on, each online node has 5 minutes to configure, the online wireless nodes will be displayed in this list. If there is no new online node in the list, please restart the wireless node;
4. Each wireless node has a unique MAC address identification, which can locate the node location through the MAC address;
5. Double click the selected wireless node to set node parameters on the left side;
6. Click write configuration to complete the node configuration;
7. On the management node page, click read all nodes configurations to view all nodes bound to the gateway.

Steps to add multiple-data node WT107:

1. Start node WT107. LED indicator will flicker once and be off. Once it has paired with gateway, LED indicator will be steady on
2. Find node WT107 on the right and double click it to configure
3. Input node WT107 parameter on the left and click Slave Setting to save it. Once node receives configuration data, LED indicator will be flickering for 2s
4. After 5 minutes' configuration, LED indicator will be off and flicker once every 8s.

BL280 LoRa Gateway V1.0 www.iot-solution.com

Read Gateway Settings Save Gateway Settings Import Gateway Profile Export Gateway Profile Device restart Default 中文 About COM5 Refresh **** Password

Basic Settings Network Settings Cloud Platform Configuration Wireless Node Management Wireless Node Historical Record Alarm Record

Slave Settings

Slave No: 8 Name: Northwest small farm Slave Model: WT107

Air Temperature	Channel Name 1	temperature	Maximum 100	Minimum 0	(° C)
Air Humidity	Channel Name 2	humidity	Maximum 100	Minimum 0	(%RH)
Illuminance	Channel Name 3	illuminance	Maximum 5000	Minimum 0	(Lx)
CO2 Value	Channel Name 4	CO2	Maximum 2000	Minimum 0	(ppm)
TVOC	Channel Name 5	TVOC	Maximum 40	Minimum 0	(ppb)
Soil	Channel Name 6	soil temperature	Maximum 50	Minimum 0	(° C)
Soil Humidity	Channel Name 7	soil humidity	Maximum 60	Minimum 0	(%RH)

Slave Setting

Configurable Slave

Slave Type	NO.	Slave Function	MAC	Status
WT102	3	Two DO Control Outputs	9A9E12	Not Configured
WT107	8	Multi Data Acquisition	3B3901	Not Configured
WT108	2	Soil PH Collection	1B2931	Not Configured
WT100	2	Transparent Transmission	3B3191	Not Configured

Note:
1. Turn on the wireless gateway.

WT Series Data Collection Node@ Wireless Node Configuration		
Item	Description	Default
Node Number	Node Identification Number	1
Input Data Type	Air Temperature	0
Input Data Type	Air Humidity	0
Input Data Type	Light Intensity	0
Input Data Type	CO2	0
Input Data Type	TVOC (air quality)	0
Input Data Type	Soil Temperature	0
Input Data Type	Soil Humidity	0
Channel Name	Can be custom	Null
Maximum	If current value reaches highest limit, system will trigger alarm and save alarm record	0
Minimum	If current value reaches lowest limit, system will trigger alarm and save alarm record	0
Slave Setting	Click it to save node configuration	--

Note: This is the example of node WT107 configuration. For other nodes, refer to [Appendix B Register Address](#)

Steps to add node WT100 (RS485 Transparent Transmission):

Based in New York City & Toronto, GAO Tek Inc. is ranked as one of the top 10 global B2B technology suppliers. GAO ships overnight within the U.S. & Canada & provides top-notch support thanks to its 4 decades of experience.

1. After WT100 is started, LED indicator will flicker once and be off
2. Select WT100 in the right list and double click it to enter configuration
3. Input WT100 parameters on the left and click Slave Setting to save it. Once node receives the configuration, LED indicator will be flickering for 2s
4. After 5 minutes configuration, LED indicator will be off. Every time transparent data is received, LED indicator will flicker.

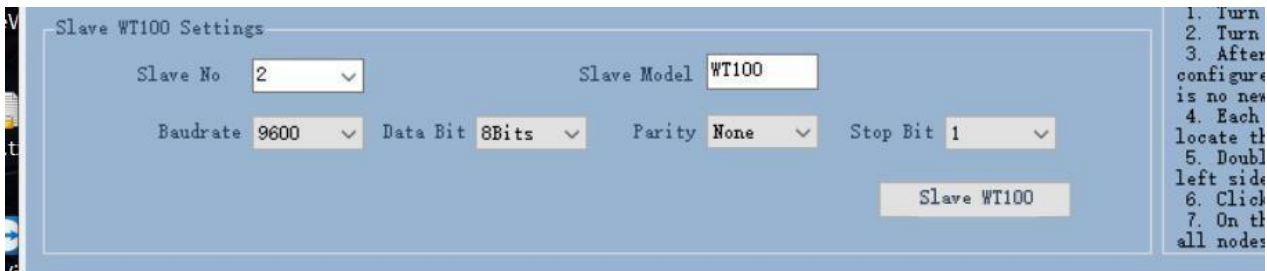

WT100 RS485 Transparent Transmission@ Wireless Node Configairton		
Item	Description	Default
Slave No.	Node Identification Number	1
Baud Rate	Select from “2400”, “4800”, “9600”, “14400”, “19200”, “38400”, “57600”, “115200”	9600
Data Bit	Select “8 Bit”, “9 Bit”	8
Parity Bit	Select “None”, “Even”, “Odd”	None
Stop Bit	Select “1 Bit”, “2 Bit”	1
Salve WT100	Click Slave WT100 to save configuration setting	--

4.6 Wireless Node Management

User can view all node setting and register information. Below page is the information of nodes already paired with gateway.

No.	Slave No	MAC	Name	Slave Type	Channel 1	Channel 2	Channel 3	Channel 4	Channel 5	Channel 6	Channel 7	Modbus Address	Status	Operation
1	3	GADE12	Northwest sm...	WT102	DO0	DO1	--	--	--	--	--	40014(04)	Online	Delete
				High limit	--	--	--	--	--	--	--	4(01)		
				Low limit	--	--	--	--	--	--	--			
2	8	3BS901	Northwest sm...	WT107	temperature	humidity	illumiance	Co2	TVOC	soil temperature	soil humidity	40049(04)	Online	Delete
				High limit	100	100	60000	100	1000	--	--			
				Low limit	0	0	0	0	0	0	0			
3	2	1B2931	Northwest sm...	WT108	PH	--	--	--	--	--	--	40007(04)	Online	Delete
				High limit	9	--	--	--	--	--	--			
				Low limit	0	--	--	--	--	--	--			
4	5	gvKwqy	Northwest sm...	WT105	temperature	--	--	--	--	--	--	40028(04)	Online	Delete
				High limit	100	--	--	--	--	--	--			
				Low limit	0	--	--	--	--	--	--			

Wireless Node Management		
Item	Description	Default
Read All Nodes Device Setting	Click to read all configured node information	--
Read Current Register Value	Click to monitor all nodes' register value (exclude WT100)	--
Delete	Delete nodes	--

4.7 Historical Record

Below page is historical record display. Active reporting data of nodes is saved. Max 2000 records can be stored.

NO.	Slave No.	Slave Type	Time	Battery Voltage	Signal Strength	Temperature	Humidity	Illuminance	CO2	TWOC	Soil Temperature	Soil Humidity
1	8	WT107	21-6-17 0:36:19	4.13V	21	29.7	49.7	212	407	8	49.7	30.4
2	8	WT107	21-6-17 0:43:9	4.15V	21	29.7	49.7	217	407	5	49.8	30.8
3	8	WT107	21-6-17 0:49:10	4.16V	21	29.8	49.6	228	408	7	49.7	31.4
4	8	WT107	21-6-17 0:55:11	4.17V	20	29.4	49.5	258	409	0	49.0	30.4

Historical Record		
Item	Description	Default
Read History	Display all historical records in the table	--
Clear Displayed Contents	Clear contents from the table	--
Export Record	Export historical records to .XML format file	--
Delete Device Record	Delete all historical records and alarm events. Start to save data from the first new record	--

Note: The temperature and other data in above table is only the data collected by WT107. If it's not WT107, the data will be different. For example, if it's WT108, then the value is soil PH. For other data type, please refer to [Appendix B Register Address](#)

4.8 Alarm Record

Based in New York City & Toronto, GAO Tek Inc. is ranked as one of the top 10 global B2B technology suppliers. GAO ships overnight within the U.S. & Canada & provides top-notch support thanks to its 4 decades of experience.



Below page is to view alarm records. It's used to save alarm events when the collected value is higher or lower than the limit. Max 500 records can be saved.

NO.	Slave No.	Slave Type	Time	Battery Voltage	Signal Strength	Temperature	Humidity	Illuminance	CO2	TWOC	Soil Temperature	Soil Humidity
1	8	WT107	21-6-17 0:36:19	4.13V	21	29.7	49.7	212	407	8	0	0
2	8	WT107	21-6-17 0:43:9	4.15V	21	29.7	49.7	217	407	5	0	0
3	8	WT107	21-6-17 0:49:10	4.16V	21	29.8	49.6	228	408	7	0	0
4	8	WT107	21-6-17 0:55:11	4.17V	20	29.4	49.5	258	409	0	0	0

Alarm Record		
Item	Description	Default
Read Alarm Record	Display all alarm records in the table	--
Clear Displayed Contents	Clear the contents from current table	--
Export Record	Export alarm records to.XML format file	--
Delete Device Record	Delete all alarm records and start to save data from the first new records.	--

Note: The temperature and other data in above table is only the data collected by WT107. If it's not WT107 (WT101 and WT102 have no alarm records), the data will be different. For example, if it's WT108, then the value is soil PH. For other data type, please refer to [Appendix B Register Address](#)

5 SMS Command

This device supports remote configuration, inquiry and control with SMS. For details, please refer to

Appendix A SMS Command List, Below are the tips:

1. Gateway default password is 1234 and can be changed with SMS to ensure safety
2. Password in SMS commands refers to device password, for example 1234, directly input it
3. “+” in SMS commands is not command message. Please don’t add any space or character
4. Make sure capital letters and lowercase letters are correctly edited in SMS commands. For example, password is PWD, not pwd

5. If password is correct but command is wrong, gateway will return message” wrong command format, please confirm”, then please check the spelling, letter format and other details
6. If password is wrong, there will be return message
7. If there’s no return message from gateway once it receives SMS command, please check whether password is correct and signal is normal.

6 Communication Protocol

Gateway S281 support Modbus TCP, Modbus RTU and MQTT. It can be connected to Alibaba Cloud, HUAWEI Cloud, King Pigeon Cloud, SCADA an other host computers through cellular and Ethernet network.

It has various nodes for collecting different data. Below is the diagram of node and register mapping relationship (For node collecting sequence, please refer to [Appendix B Register Address](#))

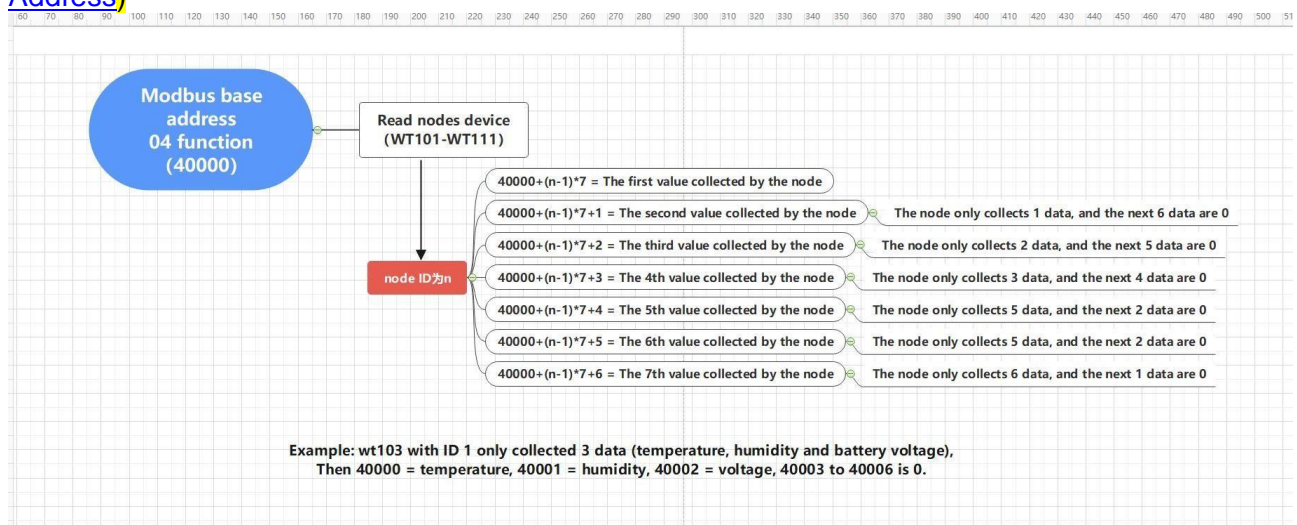

6.1 Modbus RTU Protocol

- (1) Function code 04H(0x04): read input register (read node WT107, data is air temperature, humidity, light intensity, CO2, TVOC and soil temp & humi)

Message format sent from master server station:

Content	Byte QTY	Data Sent	Remark
Device Address	1	01H	Device 01, range: 1-247, same as the set address
Function Code	1	04H	Read input register
Register Starting Address	2	9C 40H	Range: 9C40H-9C46 (40000-40006) refer to below note for address relations. Data sending sequence : high byte will be in front of low byte, for example 0010, sequence is 00 10

Qty of Read Register	7	00 07H	Range:0000H-0006H,read corresponding gateway parameter, data is sent in sequence. For example, 0008, sequence: 00 08
CRC Check	2	9E 4CH	Check according to actual requirement, low byte is in front

Note: Gateway S281 supports max 50 nodes. Up to 350 register data can be read. If more than that, data reading will be invalid. Reading register starting address is 40000(9C40H). The corresponding node register is $(n-1)*7+40000$ (n is device ID). If WT107 ID is 5, then it's needed to read 7 data consecutively starting from 40035

Return Message Format:

Content	Byte Qty	Data Sent	Remark
Device Address	1	01H	Device 01, must be the same as data sent
Function Code	1	04H	Read input register
Returned Byte Size	1	0EH	Data: 2N, N is the number of viewing register number
Returned Data	14	01 31 02 44 00 C8 01 9A 00 06 01 C2 01 F4H	From left to right, every 2 bytes refer to one gateway register parameter 0131H: 305, temperature 30.5 C; 0244H: 580, humidity 58.0 %RH; 00C8H: 200, light intensity 200 ILL; 019AH: 410, Co2 concentration 410 ppm; 0006H: 6, TVOC concentration 6 ppb; 01C2H: 450, soil temperature 45.0 C; 01F4H: 580, soil humidity 50.0 %RH.
CRC Check	2	B3 B6H	Check according to actual requirement, low byte is in front

(2) Function code 01H(0x01): read coil status (read WT102, 2 DO for control output)

Message Format sent from server master station:

Content	Byte Qty	Data Sent	Remark
Device Address	1	01H	Device 01, range: 1-247, same as the set address
Function Code	1	01H	Read coil status
Start Address of Register	2	00 00H	Read 2 channel digital output status of node WT102 with ID 1. For details, please refer to below remark.
QTY of Read Register	10	00 0AH	Range: 0000H-0009H, read 2 channels digital output status of node WT102 with ID 1-5
CRC Check	2	BC 0DH	Check according to actual status. Low byte is in front.

Note: Maximum 100 registers of digital output can be read. If more than that, it will be invalid. Each WT102 has 2 digital output and its Modbus address relation is $(ID-1)*2$. If the starting address of node WT102 with ID 1 is 0, then the starting address of node WT102 with ID 2 is 2.

Return Message Format:

Content	Byte Qty	Data Sent	Remark
Device Address	1	01H	Device 01, same as data sent
Function Code	1	01H	Read coil status
Returned Byte Size	1	02H	Data: $N / 8 + N \% 8$, N is the quantity of register to be inquired.
Returned Data	2	01 00	Returned data sequence. Low byte is in front of high byte
CRC Check	2	B8 6CH	Check according to actual requirement, low byte is in front

(3) Function code 02H(0x02): read discrete input status (Read node WT101, 4 digital inputs)

Message Format Sent from server master station:

Content	Byte Qty	Data Sent	Remark
Device Address	1	01H	Device 01, range: 1-247, same as the set address
Function Code	1	02H	Read discrete input status
Starting Address of Register	2	00 00H	Read 4 digital inputs of WT101 with ID 1. For more details, refer to below remark.
Qty of Read Register	8	00 08H	Range: 0000H-0007H, read 4 digital inputs of WT101 with ID 1 and 2
CRC Check	2	79 CCH	Check according to actual requirement, low byte is in front

Remark: Max 200 registers of digital input status can be read. If more than that, it's invalid. Each WT101 has 4 digital inputs. The corresponding Modbus address is (ID-1)*4, for example, if the starting address of node WT101 with ID 1 is 0, then the starting address of ID 2 is 4.

Return Message Format:

Content	Byte Qty	Data Sent	Remark
Device Address	1	01H	Device 01, same as data sent
Function Code	1	02H	Read discrete input status
Returned Byte Size	1	01H	Data: $N / 8 + N \% 8$, N is the quantity of register to be inquired.
Returned Data	2	F0	Every 8 bit of input data form a byte. Low byte is in front.
CRC Check	2	A1 CCH	Check according to actual requirement, low byte is in front

6.2 Modbus TCP Protocol

(1) Function code 04H(0x04): read input register (Read node WT107, data is air temperature, air humidity, light intensity, CO2, TVOC and soil temperature & humidity)

Message Format Sent from server master station:

Content	Byte Qty	Data Sent	Remark
Counter of command	1	00 00H	Every time data package is sent, the counter value will be added by 1
Counter of command	1		
Fixed character	1	00H	Fixed format, fixed character
Fixed character	1	00H	Fixed format, fixed character

Following message size	1	00 06H	Fill based on following byte size
Following message size	1		
Device Address	1	01H	Device 01, range: 1-247, same as set address
Function Code	1	04	Read input register
Starting Address of Register	2	9C 40H	Range: 9C40H-9C46(40000-40006), address definition is in below remark. Data sequence: high byte is in front. For example, 0010, the sequence is 00 10
Qty of Read Register	7	00 07H	Range: 0000H-0006H, read corresponding gateway parameter. Data sequence: high byte is in front. For example, 0008, sequence is 00 08

Note: Gateway S281 can support maximum 50 nodes. Up to 350 registers can be read. If more than that, it's invalid. Starting address of reading register is 40000(9C40H), the corresponding node register is $(n-1)*7+40000$ (n is device ID), for example if WT107 ID is 5, then read 7 consecutive data from 40035

Return Message Format

Content	Byte Qty	Data Sent	Remark
Command Counter	1	00 00H	Same as data sent
Command Counter	1		
Fixed character	1	00H	Fixed format, fixed character
Fixed character	1	00H	Fixed format, fixed character
Following message size	1	00 11H	Same as following message byte size
Following message size	1	01H	Device 01, same as data sent
Device Address	1		
Function Code	1	04H	Read input register
Return Byte Size	1	0EH	Data: $N / 8 + N \% 8$, N is the qty of register to be inquired
Return Data	14	01 26 02 2B 00 44 01 90 00 0A 01 E0 01 F4H	From left to right, every 2 bytes represents a gateway register parameters 0126H: 294, temperature 29.4 °C; 022BH: 555, humidity 55.5 %RH; 0044H: 68, light intensity 68 lx; 0190H: 400, Co2 concentration 400 ppm 000AH: 10, TVOC concentration 10 ppb; 01E0H: 480, soil temperature 48.0 °C; 01F4H: 580, soil humidity 50.0 %RH

(2) Function code 01H(0x01): read coil register (read node WT102 with 2 digital outputs)

Message Format sent from server master station:

Content	Byte Qty	Data Sent	Remark
Command Counter	1	00 00H	Every time a data package is sent, the counter value will be added by 1
Command Counter	1		
Fixed Character	1	00H	Fixed format, fixed character
Fixed Character	1	00H	Fixed format, fixed character
Following Message Size	1	00 06H	Same as following message byte size
Following Message Size	1		

Device Address	1	01H	Device 01, range: 1-247, same as set address
Function Code	1	01	Read coil register
Starting Address of Register	2	00 00H	Read 2 digital output status of WT102 with ID 1. More details can be viewed from below remark.
Qty of Read Register	10	00 0AH	Range: 0000H-0009H, read 2 digital output status of WT102 with ID 1-5

Remark: Maximum 100 registers of digital output can be read each time. If more than 100 registers, it will be invalid. Each WT102 has 2 digital outputs. The corresponding Modbus address is $(ID-1)*2$, for example, the starting address of WT102 with ID 1 is 0, then the starting address of WT102 with ID 2

Return Message Format

Content	Byte Qty	Data Sent	Remark
Command Counter	1	00 00H	Same as data sent
Command Counter	1		
Fixed Character	1	00H	Fixed format, fixed character
Fixed Character	1	00H	Fixed format, fixed character
Following Message Size	1	00 05H	Same as following message byte size
Following Message Size	1	01H	Device 01, same as data sent
Device Address	1		
Function Code	1	01H	Read coil register
Return Byte Size	1	02H	Data: 2N, N is the qty of register to be inquired
Return Data	2	01 00H	Every 8 bits form 1 byte. Low byte is in front.

(3) Function code 02H(0x02): read discrete input status (read node WT101 with 4 digital inputs)

Message Format Sent from server master station:

Content	Byte Qty	Data Sent	Remark
Command Counter	1	00 00H	Every time a data package is sent, the counter value will be added by 1
Command Counter	1		
Fixed Character	1	00H	Fixed format, fixed character
Fixed Character	1	00H	Fixed format, fixed character
Following Message Size	1	00 06H	Same as following message byte size
Following Message Size	1		
Device Address	1	01H	Device 01, range 1-247, same as set address
Function Code	1	02	Read discrete input status
Starting Address of Register	2	00 00H	Read 4 digital input status of WT101 with ID 1. More details can be viewed from below remark.
Qty of Read Register	10	00 08H	Range: 0000H-0007H, read 4 digital input status of WT101 with ID 1&2

Note: Maximum 200 registers of digital inputs can be read each time. If more than that, it's invalid. Each WT101 has 4 digital inputs. The corresponding Modbus address is $(ID-1)*4$, for example, if the starting address of WT101 with ID 1 is 0, then the starting address of WT101 with ID 2 is 4

Return Message Format

Content	Byte Qty	Data Sent	Remark
Command Counter	1	00 00H	Same as data sent
Command Counter	1		
Fixed Character	1	00H	Fixed format, fixed character
Fixed Character	1	00H	Fixed format, fixed character
Following Message Size	1	00 04H	Same as following message byte size
Following Message Size	1	01H	Device 01, same as data sent
Device Address	1		
Function Code	1	02H	Read discrete input status
Return Byte Size	1	02H	Data: 2N, N is qty of register to be inquired
Return Data	2	F0H	Every 8 bit forms 1 byte, low byte is in front

6.3 MQTT Protocol

Gateway S281 supports standard MQTT protocol, support Modbus RTU to MQTT and can be connected to cloud platform easily. More details can be viewed from [Appendix C MQTT Application](#)

7 Firmware Upgrading

This device has modular design. If there's any network upgrading from telecommunication service provider, it's not necessary to change the complete hardware but only communication module.

Firmware can be upgraded through USB port. If any requirement for firmware upgrading, please contact us.

8 Warranty Term

1) This device has one year warranty from the date of purchase. Any material or manufacturing quality problem can be repaired for free.

Any issues caused by human damage or wrong operation are beyond warranty range.

9 Appendix A SMS Command List

Change Password

Action	Command	Return Message
Set	Old password + P + new password	This is new password. Please save it.

Note: default password is 1234 and new password must be 4 digits

Set Device ID

Action	Command	Return Message
Set	Password+IDxx	ID: xx
Inquire	Password+IDE	

Note: ID is fixed character, range: 1-247, default is 1

Set Device Time

Action	Command	Return Message
Set	Password+DxxxxxxTyyyy	xxxxxxxxxxxx
Inquire	Password+D	(year, month, date, hour, minute)

Note: xxxxxx is year month date and yyyy is hour minute. Each property has 2 bits. If it's 1 bit, then add 0 in the front. For example, set device time to be 12:30, Oct 8, 2016, the command is 1234D161008T1230.

Inquire Device Status

Action	Command	Return Message
Inquire	Password+EE	Time: Device ID: IMEI: Cellular Network Signal Strength: External Power Supply Normal/Power Lost Model Number: Version: Description:

Set Network Priority

Action	Command	Return Message
Set	Password+NET	Network Priority:
Inquire	Password+NET+x	

Note: x is 0-2, 0 is Ethernet first, 1 is cellular first, 2 is both Ethernet and cellular network. For example, set Ethernet first, the command is 1234NET0

Set Cellular Network Parameter

Action	Command	Return Message
Set	Password+AP+Access Point+#+User Name+#+Password	APN: User Name:
Inquire	Password+AP	Password

Inquire Cellular Network Status

Action	Command	Return Message
Inquiry	Password+GPRSONline	GPRS is online

Set / Enable Network

Action	Command	Return Message
Enable	Cellular network: Password+GPRSON1 Ethernet: Password+ETHON1	GPRS enabled Ethernet enabled
Disable	Password+GPRSOFF Password+ETHOFF	GPRS disabled Ethernet disabled
Inquire Network Status	Password+INTE Note: INTE is fixed character	Same as above

Set Ethernet Server

Action	Command	Return Message
Set	Password+ETHIP+ IP address+*+port Note: ETHIP, * are fixed characters	Local IP: Port:
Inquire	Password+ETHIP	Same as above
Delete	Password+ETHIPDEL	Same as above (i.e. value is null)

Set Device Restart

Action	Command	Return Message
Set	Password+REBOOT	Device is rebooted successfully

Reset to Factory Setting

Action	Command	Return Message
Set	Password RESET	Device is returned to factory setting. successfully.

Inquiry Register Current Value

Action	Command	Return Message
Inquire	Password+RCU+xx-yy-zz...	R1: xxxxx (Y) R2: xxxxx (Y) Rx: xxxxx (N) Note: Y refers to normal, N means alarm

Note: RCU are fixed characters. xx , yy, zz..... represent node addresses, range: 01-50, each address has 2 bits. Single or multiple registers can be inquired. For example, inquire device 1 and 8. The command is 1234RCU0108.

Delete Node

Action	Command	Return Message
Set	Password+DELDEVxx	Node: xx, deleted successfully

Note: xx is device ID, range: 01-50. Only single node can be deleted each time.

Inquire Node Communication Status

Action	Command	Return Message
Inquire	Password+RCUC	Communication is normal: xx, yy Communication abnormal: zz.....

Note: Above is to inquiry communication status between node and gateway.

10 Appendix B Register Address

- (1) S281 registers are used for mapping and storing different node data. Input register, read only, support function code 04

Mapping Address		Data Name ^①	Data Type	Remark ^②	
Hexadecimal	Decimal				
9C 40	40000	Node 1	Air Temperature	16 bit int	Y=X/10
9C 41	40001		Air Humidity	16 bit int	Y=X/10
9C 42	40002		Light Intensity	16 bit int	Y=X
9C 43	40003		CO2 Concentration	16 bit int	Y=X
9C 44	40004		TVOC Concentration	16 bit int	Y=X
9C 45	40005		Soil Temperature	16 bit int	Y=X/10
9C 46	40006		Soil Humidity	16 bit int	Y=X/10
9C 47	40007	Node 2	Air Temperature	16 bit int	Y=X/10
9C 48	40008		Air Humidity	16 bit int	Y=X/10
9C 49	40009		Light Intensity	16 bit int	Y=X
9C 4A	40010		CO2 Concentration	16 bit int	Y=X
9C 4B	40011		TVOC Concentration	16 bit int	Y=X
9C 4C	40012		Soil Temperature	16 bit int	Y=X/10
9C 4D	40013		Soil Humidity	16 bit int	Y=X/10

...
9D 97	40343	Node 50	Air Temperature	16 bit int	Y=X/10
9D 98	40344		Air Humidity	16 bit int	Y=X/10
9D 99	40345		Light Intensity	16 bit int	Y=X
9D 9A	40346		CO2 Concentration	16 bit int	Y=X
9D 9B	40347		TVOC Concentration	16 bit int	Y=X
9D 9C	40348		Soil Temperature	16 bit int	Y=X/10
9D 9D	40349		Soil Humidity	16 bit int	Y=X/10

Note: ① There are total 11 types of node data. Different nodes collect different data as below

Node Model	Data Name	Data Type	Remark
WT101	DI-0	16 bit int	Y=X
	DI-1	16 bit int	Y=X
	DI-2	16 bit int	Y=X
	DI-3	16 bit int	Y=X
WT102	DO-0	16 bit int	Y=X

	DO-1	16 bit int	Y=X
WT103--WT104	Air Temperature	16 bit int	Y=X/10
	Air Humidity	16 bit int	Y=X/10
	Battery Voltage	16 bit int	Y=X/10
WT105--WT106	Air Temperature	16 bit int	Y=X/10
	Battery Voltage	16 bit int	Y=X/10
WT107	Air Temperature	16 bit int	Y=X/10
	Air Humidity	16 bit int	Y=X/10
	Light Intensity	16 bit int	Y=X
	CO2Concentration	16 bit int	Y=X
	TVOCCConcentration	16 bit int	Y=X
	Soil Temperature	16 bit int	Y=X/10
	Soil Humidity	16 bit int	Y=X/10
WT108	Soil PH	16 bit int	Y=X/100
WT109	Soil EC	16 bit int	Y=X
WT110	Soil Temperature	16 bit int	Y=X/10
	Soil Humidity	16 bit int	Y=X/10
	Soil PH	16 bit int	Y=X/100
	Soil EC	16 bit int	Y=X
	Soil Nitrogen	16 bit int	Y=X
	Soil Phosphorus	16 bit int	Y=X
	Soil Potassium	16 bit int	Y=X
WT111	Temperature	16 bit int	Y=X/10
	Humidity	16 bit int	Y=X/10
	Light Intensity	16 bit int	Y=X
	Wind Speed	16 bit int	Y=X/10
	Wind Direction Value	16 bit int	Y=X
	Wind Direction	16 bit int	Y=X

In remark column, the definitions of the variables as as below: Y:

true value

X: current register value

“Y=X” means “true value=current register value”,

“Y=X/10” means “true value=current register value/10”,

“Y=X/100” means “true value =current register value/100”.

WT111 wind direction and wind direction value definitions are as below:

Wind Direction (0-7 Classes)	Wind Direction Value (0-360°)	Corresponding Direction
0	0°	North wind
1	45°	Northeast wind
2	90°	East wind
3	135°	Southeast wind
4	180°	South wind
5	225°	Southwest wind
6	270°	West wind

- (2) Node WT102 has 2 digital outputs for controlling devices. S281 gateway can read and write it with function codes 01/05/15

Mapping Address		Data Name ^①		Data Type	Remark
Hexadecimal	Decimal				
00	0	Node 1	1 st digital output data DO-0	Bool	<ul style="list-style-type: none"> ● 1:Relay closed ● 0: Relay open
01	1		2 nd digital output data DO-1	Bool	<ul style="list-style-type: none"> ● 1:Relay closed ● 0:Relay open
02	2	Node 2	1 st digital output data DO-0	Bool	<ul style="list-style-type: none"> ● 1:Relay closed ● 0:Relay open
03	3		2 nd digital output data DO-1	Bool	<ul style="list-style-type: none"> ● 1:Relay closed ● 0:Relay open
...
62	98	Node 50	1 st digital output data DO-0	Bool	<ul style="list-style-type: none"> ● 1:Relay closed ● 0:Relay open
63	99		2 nd digital output data DO-1	Bool	<ul style="list-style-type: none"> ● 1:Relay closed ● 0:Relay open

Note: ①above is only for node WT102, if it's not WT102, the read value is 0. When node ID is n,the corresponding mapping address is (n-1)*2; if it's not WT102 ID, then the read value is 0

(3) Node WT101 has 4 digital inputs. S281 gateway can read it with function code 02

(4)(4)

Mapping Address		Data Name ^①		Data Type	Remark
Hexadecimal	Decimal				
00	0	Node 1	1 st digital input data DI-0	Bool	<ul style="list-style-type: none"> ● Dry contact External open: 0 External closed: 1 ● Wet contact 0-3V: 0 10-30V: 1
01	1		2 nd digital input data DI-1		
02	2		3 rd digital input data DI-2		
03	3		4 th digital input data DI-3		
04	4	Node 2	1 st digital input data DI-0	Bool	<ul style="list-style-type: none"> ● Dry contact External open: 0 External closed: 1 ● Wet contact 0-3V: 0 3-30V: 1
05	5		2 nd digital input data DI-1		
06	6		3 rd digital input data DI-2		
07	7		4 th digital input data DI-3		
...
C4	196	Node 50	1 st digital input data DI-0	Bool	<ul style="list-style-type: none"> ● Dry contact External open: 0 External closed: 1 ● Wet contact 0-3V: 0 10-30V: 1
C5	197		2 nd digital input data DI-1		
C6	198		3 rd digital input data DI-2		

C7	199	4 th digital input data DI-3	
----	-----	-----------------------------------------------	--

Note: ① Above is only for node WT101. If it's not WT101, the read value is 0. When node ID is n, the corresponding mapping address is $(n-1)*4$; if it's not WT101 ID, the read value is 0

11 Appendix C MQTT Application

(1) MQTT Introduction

MQTT is client-server based message publishing/subscription transmission protocol. It is a lightweight, simple, open and easy to implement protocol that can be used in many areas, including constrained environment like M2M and IoT. It has been widely used in satellite link communication sensors, network medical devices, smart home and other small size equipment. MQTT runs through TCP/IP or other network protocols to provide orderly, lossless and bi-directional connection.

(2) MQTT Principle

There are 3 identities in MQTT protocol: Publisher, Broker, Subscriber. Both message publisher and subscriber are clients. Message broker is server. Message publisher can be subscriber at the same time. Below is the example of connecting Gateway S281 to King Pigeon Cloud 2.0 via MQTT:

Device publishes I/O data:

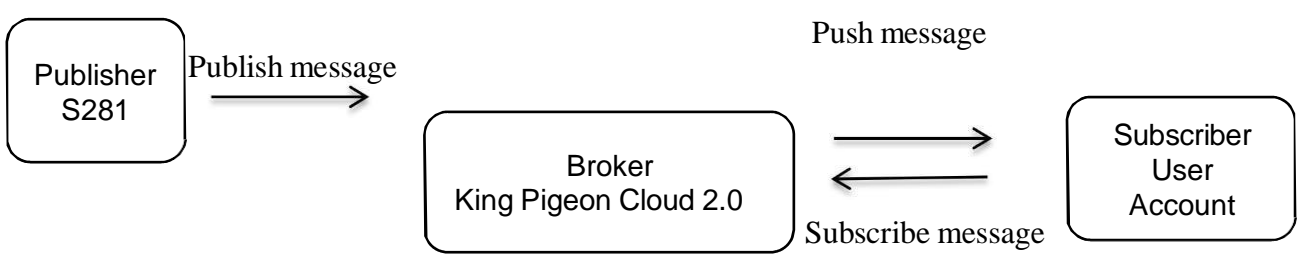

User controls device:

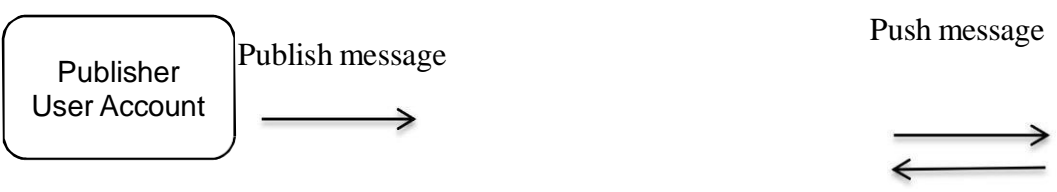

Subscribe message.

Broker
King Pigeon Cloud 2.0

Subscriber
S281

(3) Client Configuration

Below is the example of King Pigeon Cloud 2.0 configuration. For Alibaba Cloud and HUAWEICloud, input the corresponding parameters.

The screenshot displays the configuration interface for a BL280 LoRa Gateway V1.0. The browser address bar shows 'www.iot-solution.com'. The interface includes a top navigation bar with options like 'Read Gateway Settings', 'Save Gateway Settings', and 'Import Gateway Profile'. Below this, there are tabs for 'Basic Settings', 'Network Settings', 'Cloud Platform', 'Configuration Wireless Node', 'Management Wireless Node', 'Historical Record', and 'Alarm Record'. The 'Cloud Platform' tab is active, showing various connection options: 'Connect my-m2m (Modbus)', 'Connect my-m2m (MQTT)', 'Connect Kpilot 3.0', 'ALI IOT Cloud', 'HUAWEI IOT Cloud', and 'Connect other IOT server'. The 'Connect my-m2m (MQTT)' option is selected. The configuration is divided into three main sections: 'Server 1', 'Target Services', and 'MQTT Protocol Settings'. The 'Server 1' section includes fields for 'Communication Protocol' (set to MQTT Protocol), 'Login Message' (ASCII, 45645314242), 'Login ACK Message' (ASCII), 'Logout Message' (ASCII), 'Heartbeat Message' (ASCII, Q), 'Heartbeat ACK' (ASCII, A), and 'Login Message Strategy' (Send Once When Login Server). The 'Target Services' section includes 'Server 1 IP/DNS' (mqtt.dtuip.com), 'Server Listen Port' (1883), 'Protocol' (TCP), 'Heartbeat Interval' (Recommend, 60(s)), 'Idle Offline Reconnection' (Recommend, 60(s)), and 'No Response Resend Time' (Recommend, 3). The 'MQTT Protocol Settings' section includes 'Subscribe Topic' (45645314242/+), 'Publish Topic' (45645314242), 'MQTT Client ID' (45645314242), 'MQTT User Name' (MQTT), 'MQTT Password' (MQTTPW), 'Automatic data upload cycle' (Recommend, 60(s)), and 'MQTT Data retransmission' (DISABLE).

Based in New York City & Toronto, GAO Tek Inc. is ranked as one of the top 10 global B2B technology suppliers. GAO ships overnight within the U.S. & Canada & provides top-notch support thanks to its 4 decades of experience.

- 1) Communication Protocol: Select **MOTT** protocol,
- 2) Server IP/Domain Name: Broker server domain name (King Pigeon Cloud 2.0 domain name is **mqtt.dtuip.com**),
- 3) Server Port: Broker server port (King Pigeon Cloud 2.0 server port is **1883**),
- 4) Subscribe Topic: Subscription topic when device receives data from cloud (King Pigeon Cloud 2.0 subscription topic is **Device serial number /+**)
- 5) Publish Topic: The topic of publishing message when device sends data to cloud (King Pigeon Cloud 2.0 Publish Topic is **Device serial number**)
- 6) MQTT Device ID: The only identification mark of device. Can be serial number, device ID, or IMEI code (King Pigeon Cloud 2.0 MQTT Device ID is **Device serial number**)
- 7) MQTT User Name: Account for device to publish topic in broker server (King Pigeon Cloud 2.0 MQTT user name is **MOTT**)
- 8) MQTT Password: Account Password for device to publish topic in broker server (King Pigeon Cloud 2.0 User Password is **MOTTPW**)

Once configuration is done, client will initiate connection to server:

CONNECT: Client sends one CONNECT request message to server

CONNACK: Server responds with a CONNACK message to knowledge connection success

Once connection is established, client can publish or subscribe messages in server. Below is the example of using gateway device and user mobile phone as client:

After gateway device publishes topic in broker server, user can view data on mobile phone through subscription, i.e. gateway device is publisher, user mobile phone is subscriber.

User can also control gateway device through MQTT server publishing topic, i.e. user mobile phone is publisher, gateway device is subscriber.

(4) Data Format of Valid Payload in Device Published Message

Publish Topic: device serial number(same as the serial number set in configuration software)

```
{
  "sensorDatas": [
    {
      "flag": "TEMP8", //read-write mark
      "value": 288      //data type & value
    },
    {
      "flag": "HUMI8",
      "value": 450
    },
    {
      "flag": "ILLU8",
      "value": 230
    },
    {
      "flag": "CO28",
      "value": 400
    },
    {
      "flag": "TVOC8",
      "value": 8
    },
    {
      "flag": "SOILHUMI8",
      "value": 456
    },
    {
      "flag": "SOILTEMP8",
      "value": 333
    }
  ],
}
```

```
"time": "07:16:17 06/16/2021 UTC",
```

```
//Time mark it's UTC time
```

```
"state": "alarm",
```

```
//Alarm, recovery mark (this mark only appears when there's alarm and data recovery.
```

```
Otherwise it's not included in scheduled uploading data)
```

```
"retransmit": "enable"
```

```
//historical data mark (this mark only appears when there's data re-transmission. It's not  
included in real time data)
```

```
}
```

Note:

```
//read-write mark, character is "flag", following is "read-write mark of node collecting datapoints"
```

```
//Data type & value, following are the data types:
```

1. Digital data: data is "switcher", followed by "0" or "1" (0 represents open, 1 represents closed)
2. Numeric data: character is "value", followed by "actual value", this data can not be changed or sent to device from cloud

```
//Time mark: the character is "time", followed by "actual uploading UTC time"
```

//Alarm & recovery: the character is "state", followed by "alarm" or "recovery" (alarm represents alarm data, recovery represents recovery data)

//Historical data mark: the character is "retransmit", followed by "enable", data during network disconnection will be saved in the device temporarily. Once network is connected, it will be published with "retransmit" mark to represent historical data (MQTT re-transmission function must be enabled in configuration software)

(5) Data Format of Valid Payload in Device Subscribed Message

Subscribe Topic: Device serial number/+ (same as the one set in configuration software)
(King Pigeon Cloud 2.0 use "device serial number/sensor ID" as message publish topic. Thus device subscribe topic must add wildcard "/" so that cloud can send data to control device)

```
{
  "sensorDatas":
  [
    {
      "sensorId": 211267, //Cloud platform sensor ID
      "switcher": 1,     //Data type & value
      "flag": "DO3_1"   //Read-write mark
    }
  ],
  "down": "down"      //Data mark sent from cloud platform
}
```

Note”

//Cloud platform sensor ID: the character is "sensorID", followed by ID number (ID is automatically generated by cloud platform)

//Data type & value. It has following data types:

1. Digital data: the character is "switcher", followed by "0" or "1" (0 represents open, 1 represents closed)

2. Numeric data: the character is "value", followed by "actual value"

//Read-write mark, the character is "flag", followed by "read-write mark of IO datapoints"

//Mark of message sent from cloud platform: the character is "down", followed by "down", it represents data sent from cloud platform

(6) Read-write Mark of Node Collecting Datapoints

Data Name	Read-write Mark ^①	Data Type	Read-Write Type	Remark ^③
Air Temperature	TEMPx	Value	Read only	True Value=Original Value / 10
Air Humidity	HUMIx	Value	Read only	True Value=Original Value / 10
Light Intensity	ILLUx	Value	Read only	True Value=Original Value
Co2 Concentration	CO2x	Value	Read only	True Value=Original Value
TVOC Concentration	TVOCx	Value	Read only	True Value=Original Value
Soil Temperature	SOILTEMPx	Value	Read only	True Value=Original Value / 10
Soil Humidity	SOILHUMIx	Value	Read only	True Value=Original Value / 10

Soil PH	SOILPH _x	Value	Read only	True Value=Original Value / 100
Soil EC	SOILEC _x	Value	Read only	True Value=Original Value
Soil Nitrogen	SOILN _x	Value	Read only	True Value=Original Value
Soil Phosphorus	SOILP _x	Value	Read only	True Value=Original Value
Soil Potassim	SOILK _x	Value	Read only	True Value=Original Value
1st digital output	DO _{x_0}	Switcher	Read & Write	0 is Open, 1 is Closed
2 nd digital output	DO _{x_1}	Switcher	Read & Write	0 is Open, 1 is Closed
1 st digital input	DI _{x_0}	Switcher	Read only	0 is Open, 1 is Closed
2 nd digital input	DI _{x_1}	Switcher	Read only	0 is Open, 1 is Closed
3 rd digital input	DI _{x_2}	Switcher	Read only	0 is Open, 1 is Closed
4 th digital input	DI _{x_3}	Switcher	Read only	0 is Open, 1 is Closed
Node power voltage ^②	BAT _x	Value	Read only	True Value=Original Value / 10

Note:

- ① lower case letter x is node ID, for example “TEMP_x” means TEMP1. It’s the temperature of node with ID 1
- ② Node power voltage only exists in node WT103, WT104, WT105 and WT106
- ③ In Alibaba Cloud and HUAWEI Cloud, the true value=actual value

Different nodes collect different data. Details can be viewed from [Appendix B Register Address](#)

12 Appendix D LoRa Node Introduction

WT100 (RS485 Transparent Transmission Node)

Introduction:

Micropower Wireless LoRa Node WT100 is serial port transparent transmission module. It's based on LoRa spread spectrum modulating technology with half-duplex communication. It has MCU with receiving-transmission program for transparent data transmission. Users don't need to do programming. It can be used easily on the site without configuration.

Remote transmission node WT100 can connect RS485 devices or sensors to Gateway S281 and cloud to collect data from cloud. Multiple Multiple WT100s can form a group network. Master will collect data from other WT100.



It's commonly applied in remote meter reading, access control system, wireless data communication, industrial data collection, remote control telemetry, security system, robot control, etc.

Product Features

- Support 3.3V~24VDC power supply
- Effective forward error correction coding technology and frequency hopping mechanism for anti-interference and low bit error rate
- Unique physical address to be identified easily from other nodes
- Communication parameters can be flexibly configured
- Receiving sensitivity can be up to -148dBm and max transmission power can be +20dBm
- Anti-electromagnetic interference port design to ensure reliable RS485 data transmission.

Parameter	Specification
Wire Definition	1 st pin red: power+
	2 nd pin black: power-
	3 rd pin white: RS485+
	4 th pin yellow RS485-
	5 th pin green: GND
Power Supply	DC12V (can be 3.3V~24V)
Power Consumption	Standby: 30mW, data communication:500mW
Serial Port Parameter	Baud rate: 9600, data bit:8,parity bit:none,1;(can be adjusted)
Work Mode	Transparent Transmission (Multiple WT100s can communicate with each other)
Serial Port Cache	200bytes
Communication Frequency	402MHz~500MHz, 860MHz-930MHz, 860MHz-930MHz860MHz-930MHz
Working Environment	Temperature-10~+70°C; humidity ≤95%
LoRa Antenna	External SMA antenna with inner pin and screw thread 433MHz/868MHz/915MHz optional
Waterproof Grade	IP65

Outline Dimension	101mmX69mmX39mm
Packing List	Node WT100x1; 12V Power Adapter x1; LoRa Antennax1

WT101(4 Digital Input Data Collection Node)

Introduction

Wireless Node WT101 has 4 digital input channel. It works with LoRa Gateway S281, supporting wet contact and dry contact(default is wet contact). Collected data is sent to S281 automatically.

It can be used in various industrial automation monitoring system.

Product Features:

- Private LoRa communication protocol for simple, safe and reliable connection
- Parameters can be set in S281 configuration software
- Unique physical address to be identified from other nodes easily
- Smart transmitting mechanism to auto adjust next transmission according to node number once it's configured with Gateway
- Automatic re-connecting to gateway once it's offline to prevent Open



connection between gateway and node

Parameter	Specification
Digital Input	4 channels
DIN Parameters	DIN default is wet contact. For dry contact please put remark in the order Dry Contact: External open: internal data is 0 External closed: internal data is 1 : Wet Contact: Logic 0: 0-3VDC Logic 1: 10-30VDC (DI COM ~ DI)
Work Mode	Automatic reporting data
Communication Frequency	402MHz~500MHz, 860MHz-930MHz
Power Consumption	Standby≤38mA @12V, data communication≤100mA @12V
LoRa Antenna	External SMA antenna with inner pin and screw thread 433MHz/868MHz/915MHz optional
Communication Range	2km(open area)
Waterproof Grade	IP65
Mounting	Wall-Mounting, DIN Rail Mounting
Outline Dimension	101mmX69mmX39mm
Packing List	Node WT101 x1; LoRa Antennax1

WT102 (2 Relay Output Control Node)

Introduction

Wireless Remote-Control Node WT102 has 2 Relay outputs. It works with LoRa Gateway S281 to realize remote wireless control. It's widely used in various industrial automation control systems.

Product Features:

Based in New York City & Toronto, GAO Tek Inc. is ranked as one of GAO ships overnight within the U.S. & Canada & provides top-notch s



pliers.
erience.

- Private LoRa communication protocol for simple, safe and reliable connection
- Parameters can be set in S281 configuration software
- Unique physical address to be identified from other nodes easily
- Smart transmitting mechanism to auto adjust next transmission according to node number once it's configured with Gateway
- Automatic re-connecting to gateway once it's offline to prevent Open connection between gateway and node

Parameter	Specification
Relay Output	2 Channels
Relay Parameter	7A*175V(AC) or 5A*250V(AC) or 20A*14V(DC)
Response Time	Response time $\leq 2s$
Working Mode	Scheduled automatic wake-up and reporting
Communication Range	402MHz~500MHz, 860MHz-930MHz
Power Supply	DC12V
Power Consumption	Standby $\leq 120mA$ @12V, Data communication $\leq 182mA$ @12V
LoRa Antenna	External SMA antenna with inner pin and screw thread 433MHz/868MHz/915MHz optional

Communication Range	2km (open area)
Waterproof Grade	IP65
Outline Dimension	101mmX69mmX39mm
Packing List	WT102Node x1; LoRa Antennax1

WT103 (AM2301 Temperature & Humidity Data Collection Node)

Introduction

Remote Wireless LoRa Node WT103 is a highly effective, low power consumption and long range communication module. It works with LoRa Gateway S281 to collect air temperature & humidity data and automatically send it to S281. With high quality sensing core, it's compliant with WMO (World Meteorological Organization) regulations. It's widely used in weather, environment, agriculture, breeding industry and warehouse area.



Product Features:

- Private LoRa communication protocol for simple, safe, and reliable connection
- Parameters can be set in S281 configuration software.
- Unique physical address to be identified from other nodes easily.
- Low power consumption scheduled automatic wake-up and reporting data from sleep mode.
- Smart transmitting mechanism to auto adjust next transmission according to node number once it's configured with Gateway.
- Real-time battery voltage can be sent to prevent data loss caused by battery shortage.

Parameter	Specification
Temperature Range	-40~+80°C, Precision:±1°C
Humidity Range	0~100% RH, Precision:±4.5%
Working Mode	Scheduled automatic wake-up

Based in New York City & Toronto, GAO Tek Inc. is ranked as one of the top 100 IoT companies in the world. GAO ships overnight within the U.S. & Canada & provides top-notch support.



pliers.
erience.

Communication Range	402MHz~500MHz, 860MHz-930MHz
Power Supply	#7 battery*3 (3.3V~5V)
Power Consumption	Sleep mode $\leq 10\mu\text{A}@5\text{V}$, data communication $\leq 120\text{mA}@5\text{V}$
LoRa Antenna	External SMA antenna with inner pin and screw thread 433MHz/868MHz/915MHz optional
Communication Range	2km(open area)
Waterproof Grade	IP65
Outline Dimension	101mmX69mmX39mm
Packing List	WT103Node x1; LoRa Antennax1

WT104 (AM2401 Temperature & Humidity Data Collection Node)

Introduction

Remote Wireless LoRa Node WT104 is a highly-effective, low power consumption and long range communication module. It works with LoRa Gateway S281 to collect air temperature & humidity data and automatically send it to S281. With high quality sensing core, it's compliant with WMO (World Meteorological Organization) regulations. It's widely used in

weather, environment, agriculture, breeding industry and warehouse area

Product Features:

- Private LoRa communication protocol for simple, safe and reliable connection
- Parameters can be set in S281 configuration software
- Unique physical address to be identified from other nodes easily
- Low power consumption, scheduled automatic wake-up and reporting data from sleep mode
- Smart transmitting mechanism to auto adjust next transmission according to node number once it's configured with Gateway
- Real-time battery voltage can be sent to prevent data loss caused by battery shortage

Parameter	Specification
Temperature Range	-40~+80°C, Precision:±0.3°C
Humidity Range	0~100%RH, Precision:±4.5%
Working Mode	Scheduled automatic wake-up and reporting
Communication Range	402MHz~500MHz, 860MHz-930MHz
Power Supply	#7 battery*3 (3.3V~5V)
Power Consumption	Sleep mode ≤10μA@5V, data communication ≤120mA @5V
LoRa Antenna	External SMA antenna with inner pin and screw thread 433MHz/868MHz/915MHz optional
Communication Range	2km(open area)
Waterproof Grade	IP65
Outline Dimension	101mmX69mmX39mm
Packing List	WT104Node x1; LoRa Antennax1

WT105 (DS18B20 Temperature Data Collection Node)

Introduction:

Wireless LoRa Node WT105 use sensor DS18B20 to collect temperature data. DS18B20 is a commonly used temperature sensor

Based in New York City & Toronto, GAO Tek Inc. is ranked as one of the top 10 glo
GAO ships overnight within the U.S. & Canada & provides top-notch support thank



with compact size, low cost, strong anti-interference and high precision features. It can be used in cable tunnel, blast furnace, boiler, computer room, greenhouse, clean workshop, ammunition warehouse and other small size area temperature monitoring.

Product Features:

- Private LoRa communication protocol for simple, safe and reliable connection
- Parameters can be set in S281 configuration software.
- Unique physical address to be identified from other nodes easily.
- Low power consumption scheduled automatic wake-up and reporting data from sleep mode.
- Smart transmitting mechanism to auto adjust next transmission according to node number once it's configured with Gateway.
- Real-time battery voltage can be sent to prevent data loss caused by battery shortage.

Parameter	Specification
Temperature Range	-40~+80°C, Precision:±0.3°C
Working Mode	Schedule automatic wake-up and reporting
Communication Range	402MHz~500MHz, 860MHz-930MHz
Power Supply	#7 battery*3 (3.3V~5V)
Power Consumption	Sleep mode≤10μA@5V, data communication≤120mA @5V
LoRa Antenna	External SMA antenna with inner pin and screw thread 433MHz/868MHz/915MHz optional
Communication Range	2km(open area)
Waterproof Grade	IP65
Outline Dimension	101mmX69mmX39mm
Mounting	Wall-Mounting, Horizontal placement
Packing List	WT105Node x1; LoRa Antennax1

WT106 (PT100 Temperature Data Collection Node)

Introduction:

Wireless LoRa Node WT106 use PT100 thermocouple to monitor temperature. It's a widely used component for measuring temperature -50°C~600°C with high precision, stability and anti-interference capability. PT100 can convert the sensed temperature to analog value. It's used in industrial, electronics, machine tool, metallurgy, petroleum and chemical industries.

Device has been calibrated in factory. If it's necessary to change sensor and re-calibrate it, please refer to related calibration document



Product Features:

- Private LoRa communication protocol for simple, safe and reliable connection
- Parameters can be set in S281 configuration software
- Unique physical address to be identified from other nodes easily
- Automatic shifting from Working Mode to Low Power Consumption Mode based on power voltage
- Smart transmitting mechanism to auto adjust next transmission according to node number once it's configured with Gateway
- Real-time battery voltage can be sent to prevent data loss caused by battery shortage

Parameter	Specification
Temperature Range	-50~+200°C; Precision $\pm 0.2^{\circ}\text{C}$
Working Mode	Scheduled automatic wake-up and reporting; (Voltage $\leq 6\text{V}$) Normal Working Mode; (voltage $\geq 6\text{V}$)
Communication Range	402MHz~500MHz, 860MHz-930MHz
Power Supply	#7 battery*3 (3.3V~5V) or 12VDC power supply

Power Consumption	<p>Lower power consumption mode: sleep mode $\leq 20\mu\text{A}$ @5V, working $\leq 140\text{mA}$ @5V</p> <p>Normal Working Mode: Standby $\leq 30\text{mA}$ @12V, data communication $\leq 140\text{mA}$ @5V</p>
LoRa Antenna	External SMA antenna with inner pin and screw thread 433MHz/868MHz/915MHz optional
Communication Range	2km(open area)
Waterproof Grade	IP65
Outline Dimension	101mmX69mmX39mm
Mounting	Wall-Mounting; Horizontal placement
Packing List	WT106Node x1; LoRa Antennax1; 12VDC power adapter(Optional)

WT107 (Multiple Environmental Data Collection Node)

Introduction

Wireless LoRa Node WT107 is used to monitor multiple environmental data. It collects air temperature & humidity, light intensity, CO₂, TVOC and soil temperature & humidity. It's mainly used for environmental condition monitoring in smart greenhouse, orchard, garden, etc.



Product Features:

- Private LoRa communication protocol for simple, safe and reliable connection
- Parameters can be set in S281 configuration software
- Unique physical address to be identified from other nodes easily
- Smart transmitting mechanism to auto adjust next transmission according to node number once it's configured with Gateway
- Automatic re-connecting to gateway once it's offline to prevent Open connection between gateway and node

Based in New York City & Toronto, GAO Tek Inc. is ranked as one of the top 10 IoT companies in the world. GAO ships overnight within the U.S. & Canada & provides top-notch support.



ers.
nce.

Parameter	Specification
Temperature Range	-40~+125°C, Precision:±0.5°C
Humidity Range	0~100%RH, Precision:±5%
Light Intensity Range	1~65535lx, Precision:±20%
CO2 Measurement Range	400~60000ppm Range: 400 ~ 1479ppm Precision: 1ppm, Range:1479 ~ 5144ppm Precision: 3ppm, Range:5144~17597ppm Precision: 9ppm Range:17597~60000ppm Precision: 31ppm
TVOC Measurement Range	0~60000ppb Range: 0~2008ppb Precision:1ppb, Range: 2008~11110ppb Precision: 6ppb, Range: 11110~60000ppb Precision: 32ppb
Soil Temperature Range	-40~+80°C, Precision:±0.5°C
Soil Humidity Range	0~100%RH, Precision:0~53%为±3%, 53%~100%为±5%
Working Mode	Scheduled automatic reporting
Communication Range	402MHz~500MHz, 860MHz-930MHz
Power Supply	DC12V
Power Consumption	Standby≤83mA @12VData communication≤145mA @12V
LoRa Antenna	External SMA antenna with inner pin and screw thread 433MHz/868MHz/915MHz optional
Communication Range	2km(open area)
Waterproof Grade	IP65
Outline Dimension	101mmX69mmX39mm
Packing List	WT107Node x1; LoRa Antennax1

WT108 (Soil PH Value Collection Node)

collected data is sent to S281 automatically. Premium sensing core is used for high precision and stable output. It's commonly used for soil PH monitoring in scientific experiment, irrigation, greenhouse, orchard and foodstuff storage area.

Product Features:

- Private LoRa communication protocol for simple, safe and reliable connection
- Parameters can be set in S281 configuration software
- Unique physical address to be identified from other nodes easily
- Smart transmitting mechanism to auto adjust next transmission according to node number once it's configured with Gateway
- Automatic re-connecting to gateway once it's offline to prevent Open connection between gateway and node
- High anti-corrosion, electrolyte resistance and waterproof features to ensure it can be used in various soil for long time sensing

Parameter	Specification
Soil PH Measurement Range	0~14PH, Precision:0.01PH
Working Mode	Scheduled automatic reporting
Communication Range	402MHz~500MHz, 860MHz-930MHz
Power Supply	DC12V
Power Consumption	Standby≤44mA @12V Data communication≤106mA @12V
LoRa Antenna	External SMA antenna with inner pin and screw thread 433MHz/868MHz/915MHz optional
Communication Range	2km(open area)
Waterproof Grade	IP65
Outline Dimension	101mmX69mmX39mm
Packing List	WT108Node x1; LoRa Antennax1

WT109 (Soil EC Data Collection Node)

Introduction:

Wireless LoRa Node WT109 is used to collect soil EC value, i.e. electrical conductivity. It works with LoRa Gateway S281. Once it's configured, the collected data is sent to S281 automatically. Premium sensing core is used for high precision and stable output. It's commonly used for soil EC monitoring in scientific experiment, irrigation, greenhouse, orchard and foodstuff storage area.

**Product Features:**

- Private LoRa communication protocol for simple, safe and reliable connection
- Parameters can be set in S281 configuration software
- Unique physical address to be identified from other nodes easily
- Smart transmitting mechanism to auto adjust next transmission according to node number once it's configured with Gateway
- Automatic re-connecting to gateway once it's offline to prevent Open connection between gateway and node
- High anti-corrosion, electrolyte resistance and waterproof features to ensure it can be used in various soil for long time sensing

Parameter	Specification
-----------	---------------

Soil EC Measurement Range (Electrical Conductivity)	0~2000us/cm, Range: 0~1000us/cm Precision: ±3% , Range: 1000~2000us/cm Precision: ±5%
Working Mode	Scheduled automatic reporting
Communication Range	402MHz~500MHz, 860MHz-930MHz
Power Supply	DC12V
Power Consumption	Standby≤44mA @12V Data communication≤106mA @12V
LoRa Antenna	External SMA antenna with inner pin and screw thread 433MHz/868MHz/915MHz optional
Communication Range	2km(open area)
Waterproof Grade	IP65
Outline Dimension	101mmX69mmX39mm
Packing List	WT109Node x1; LoRa Antennax1

WT110 (Soil Moisture Content Data Collection Node)

Introduction:

Wireless LoRa Node WT110 is used to collect various soil parameters. It mainly monitors soil moisture contents, including soil temperature & humidity, soil PH, soil EC, soil Nitrogen, soil Phosphorus and soil Potassium. It works with LoRa Gateway S281. Once it's configured, the collected data is sent to S281 automatically. Premium sensing core is used for high precision and stable output. It's commonly used for soil parameters collection in scientific experiment, greenhouse, orchard, water sewage and foodstuff storage area.



Product Features:

- Private LoRa communication protocol for simple, safe and reliable connection

- Parameters can be set in S281 configuration software
- Unique physical address to be identified from other nodes easily
- Smart transmitting mechanism to auto adjust next transmission according to node number once it's configured with Gateway
- Automatic re-connecting to gateway once it's offline to prevent Open connection between gateway and node
- High anti-corrosion, electrolyte resistance and waterproof features to ensure it can be used in various soil for long time sensing
- Multiple parameters can be collected for evaluating soil quality easily

Parameter	Specification
Soil Temperature Range	-40~+80°C, Precision:±0.5°C
Soil Humidity Range	0~100%RH, Precision:0~53%为±3%, 53%~100%为±5%
Soil PH Range	0~14PH, Precision:0.01PH
Soil EC Range	0~2000us/cm, Range: 0~1000us/cm Precision: ±3% , Range: 1000~2000us/cm Precision:±5%
Soil Nitrogen Range	0~1999mg/kg, Precision:±2%F.s
Soil Phosphorus Range	0~1999mg/kg, Precision:±2%F.s
Soil Potassium	0~1999mg/kg, Precision:±2%F.s
Working Mode	Scheduled automatic reporting

Communication Range	402MHz~500MHz, 860MHz-930MHz
Power Supply	DC12V
Power Consumption	Standby≤120mA @12V Data communication≤182mA @12V
LoRa Antenna	External SMA antenna with inner pin and screw thread 433MHz/868MHz/915MHz optional
Communication Range	2km(open area)
Waterproof Grade	IP65
Outline Dimension	101mmX69mmX39mm
Packing List	WT110Node x1; LoRa Antennax1

WT111 (Multiple-Parameter Collection Node)

Introduction

Remote Wireless LoRa Node WT111 is used to collect various parameters, including air temperature & humidity, wind speed, wind direction and light intensity.. It works with LoRa Gateway S281 to collect the data and automatically send it to S281. With high quality sensing core, it's compliant with WMO (World Meteorological Organization) regulations. It's widely used in weather, environment, agriculture, breeding industry, etc.



Product Features:

- Private LoRa communication protocol for simple, safe and reliable connection
- Parameters can be set in S281 configuration software
- Unique physical address to be identified from other nodes easily
- Low power consumption, scheduled automatic wake-up and reporting data from sleep mode
- Smart transmitting mechanism to auto adjust next transmission according to node number once it's configured with Gateway
- Automatic re-connecting to gateway once it's offline to prevent Open connection between gateway and node

Parameter	Specification
Temperature Range	-40~+125°C, Precision:±0.5°C
Humidity Range	0~100%RH, Precision:±5%
Wind Speed Range	0~60m/s, Precision:0.3m/s
Wind Direction Range	0°~360°, Precision:3°
Light Intensity Range	1~65535lx, Precision: ±20%
Working Mode	Scheduled automatic reporting
Communication Range	402MHz~500MHz, 860MHz-930MHz
Power Supply	DC12V
Power Consumption	Standby≤60mA @12VData communication≤122mA @12V
LoRa Antenna	External SMA antenna with inner pin and screw thread 433MHz/868MHz/915MHz optional
Communication Range	2km(open area)
Waterproof Grade	IP65
Outline Dimension	101mmX69mmX39mm
Packing List	WT111Node x1; LoRa Antennax1

Contact us: sales@gaotek.com