



<b>Product Name</b>	<b>GAOTek Professional Drone</b>
<b>Product SKU</b>	<b>GAOTek-LRD-163</b>
<b>Product URL</b>	<a href="https://gaotek.com/product/gaotek-professional-drone-2/">https://gaotek.com/product/gaotek-professional-drone-2/</a>

Contact us: [sales@gaotek.com](mailto:sales@gaotek.com)

## CONTENTS

1. INTRODUCTION:.....	3
2. SPECIFICATIONS: .....	3
3. AIRCRAFT: .....	16
4. REMOTE CONTROLLER: .....	22
5. FLIGHT:.....	31
6. FLY APP: .....	47
7. APPENDIX: .....	51

# GAOTek Professional Drone

## 1. INTRODUCTION:

Sprinkle Drone 4 is our 5th and the latest generation of waterproof drones, representing Sprinkle Pro's 7 years of knowledge and understanding of drone waterproofing technology. Sprinkle Drone 4 is the all-new waterproof flight & float platform designed for multipurpose operation in any harsh environment. With its modular payload system design and our variety of payload choices, the Sprinkle Pro SD4 can quickly adapt to different tasks in the field.

## 2. SPECIFICATIONS:

<b>SD &amp; Accessories Specification</b>	
<b>Aircraft</b>	
Waterproof Rating:	IP67
Weight (include battery and propellers) :	2.18 kg
Axis Diameter:	450 mm
Max Ascend Speed:	4 m/s
Max Descent Speed:	4 m/s
Max Flight Speed:	22 m/s (ATTI), 10 m/s (GPS)
Max Tilt Angle:	ATTI: 12.5°; ATTI (fast): 25°
Max Altitude from Takeoff Point:	120m (GPS) / ATTI - no limitation
Max Wind Speed Resistance:	72 km/h   20 m/s   39 knots
Max Flight Time:	30 mins (no wind & no load); (approx. 25 mins with GC3-S, approx.15 mins with a load of 1.5kg)
Hovering Precision:	±0.5 m (vertical); ±0.5 m (horizontal)
Max Flight Distance :	5.0 km
Max Payload Capacity:	2.0 kg
Flight Control:	Hawk
Digital Video Transmission:	MultiSync
Motor:	#3509 - 740Kv (special coated)
ESC:	40A (flux)
Propellers:	#1242 carbon fiber quick release propellers
Motors:	#3509 - 740Kv
Operating Frequency:	5180 - 5875 MHz

Transmitter Power (EIRP):	FCC/IC: $\leq$ 24 dBm CE/SRRC/MIC: $\leq$ 20 dBm
Working Temperature:	-10°C ~ 40°C
Satellite Positioning Systems:	GPS/GLONASS
Pass-through Serial Port:	Connect to a third-party device and transfer the data of the third-party device to the remote control
UART:	Allows for TTL serial port to TCP, with baud rate of 115200
Wi-Fi Hotspot	IP: 192.168.1.101:2222
Power Input:	12V/2A   5V/2A
<b>Remote Controller (MRC)</b>	
Waterproof Rating:	IP66
Operating Frequency:	5180 - 5875 MHz
Transmitter Power (EIRP)	FCC/IC: $\leq$ 24 dBm CE/SRRC/MIC: $\leq$ 20 dBm
Real-time Video Transmission:	720P@30fps
Latency:	200 ms (It depends on the actual shooting environment and mobile devices)
Battery:	2S 3600mAh
Working Time:	7 hours
Working Current/Voltage:	0.3A/7.4V
Ethernet Port:	IP: 192.168.2.220:2222
Wi-Fi Hotspot	IP: 192.168.2.220: 2020; Default password: 12345678
Mobile Device Mount:	Suitable for any size phones; Tablets require an larger mount(sold separately)
Screen:	2.68 inch, 128x64
Working Temperature:	-10°C - 40°C
Remote Charging time:	3 hours
Power Input:	5V/2A
<b>Intelligent Battery (IB4)</b>	
Nominal Capacity:	6600mAh
Voltage:	14.8V
Type:	Intelligent 4S LiPo
Watt Hours:	97.68 Wh
Size:	153.6*82.4*48.3mm
Weight:	735 g ( $\pm$ 5 g)
Working Temperature:	-10°C - 40°C
Charging Time:	1.5 hour
Max Charging Power:	84 W

<b>Charger</b>	
Input	100 – 240V, 50/60Hz
Output:	16.8V@Dynamic Current / 5V@1.5A
Rated Power:	84.5 W
<b>Mobile Device connection</b>	
Operation Frequency	5180 - 5875 MHz
Max Transmission Distance (Unobstructed, free of interference)	10 m
<b>APP</b>	
Mobile App Name	FLY
Live View Quality	720p@30fps
Latency	< 250 ms (depending on environmental conditions and mobile devices)
<b>1-Axis Gimbal Camera (GC1-S)</b>	
Waterproof:	IP67
Axis:	1-axis (tilt)
Controllable range:	tilt: -90° to 0°
Max control speed:	tilt: 60°/s
Weight:	Approx. 145g
Size:	71*55*65mm
Sensor:	1/2.3" 12M SONY CMOS
Lens:	F4.53mm f/2.65, FOV: 92.6°
ISO Range:	100 - 3200
Shutter Speed	16 - 1/16000 s
Photo Resolution:	4:3/16:9 12MP
Burst Mode:	3/5/10 pcs
Video Resolution:	4K: 3840*2160/30P   2.7K: 2704*1520/60P   FHD: 1920*1080 30/60/120P   HD: 1280*720/240P
Max Video Bitrate:	64 Mbps
Photo Format:	JPEG / DNG (RAW)
Video Format:	MP4 / MOV
Memory Card:	Micro SD card: supports up to 128GB of capacity, write speeds ≥ 60 MB/s, recommend using Class 10 or above, or with UHS-1 rating.
Working Temperature:	-10°C to 40°C

<b>2-Axis Night Vision Gimbal Camera (GC2-S)</b>	
Waterproof:	IP67
Axis:	2-axis (tilt, roll)
Controllable range:	tilt: -90° to 0°
Max control speed:	tilt: 60 °/s
Weight:	Approx.220g
Size:	113*92*80mm
Sensor:	1/2" 2M Starlight CMOS
Lens:	FOV: 66°
Burst Mode:	3/5/10 pcs
Video Resolution:	FHD: 1920*1080 30/60P   HD: 1280*720 120/60P
Max Video Bitrate:	64 Mbps
Photo Format:	JPEG
Video Format:	MP4 / MOV
Memory Card:	Micro SD card: supports up to 128GB of capacity, write speeds ≥ 40 MB/s, recommend using Class 10 or above, or with UHS-1 rating.
Working temperature:	-10°C to 40°C
<b>3-Axis Gimbal Camera (GC3-S)</b>	
Waterproof:	IP67
Axis:	3-axis (tilt, pan, roll)
Controllable range:	tilt: -90°to 0°
Max Control Speed:	tilt: 60°/s
Weight:	Approx. 310g
Size:	113*92*110mm
Sensor:	1/2.3" 12M SONY CMOS
Lens:	F4.53mm f/2.65, FOV: 92.6°
ISO range:	100 - 3200
Shutter Speed	16 - 1/16000 s
Photo Resolution:	4:3/16:9 12MP
Burst Photo:	3/5/10 pcs
Video Resolution:	4K: 3840*2160/30P   2.7K: 2704*1520/60P   FHD: 1920*1080 30/60/120p   HD: 1280*720/240p
Max Video Bitrate:	64 mbps
Photo Format:	JPEG / DNG (RAW)

Video Format:	MP4, MOV
Memory Card:	Micro-SD card with a maximum capacity of 128GB, write speed $\geq 60$ MB/s, recommend using Class 10 or above & UHS-1 rating
Working temperature:	-10°C to 40°C
<b>3-Axis Thermal Gimbal Camera (GC3-T)</b>	
Waterproof:	IP67
Axis:	3 axis (tilt, pan, roll)
Controllable range:	tilt: -90° to 0°
Max control speed:	tilt: 60°/s
Weight:	Approx. 450g
Size:	110*100*115mm
<b>Low-light Camera</b>	
Image Sensor:	1/2" 2M Starlight CMOS
Lens:	FOV: 66°
Burst Photo:	3/5/10pcs
Video Resolution:	FHD: 1920*1080 30/60p   HD: 1280*720 120/60p
Max Video Stream:	64 Mbps
Photo Format:	JPEG
Video Format:	MP4 / MOV
Support Memory Card:	Micro SD card: supports up to 128GB of capacity, write speeds $\geq 60$ MB/s, recommend using Class 10 or above, or with UHS-1 rating.
Working temperature:	-10°C to 40°C
<b>IR Camera</b>	
Image Sensor:	Vanadium oxide uncooled infrared focal plane detector
Lens:	19mm/25mm
Resolution @ frame rate:	640*512 @30p/48p/50p
Palette:	White hot/black hot / Rainbow / Rainbow high contrast/iron red / lava / Sky / medium gray/grey red / purple orange / Special 1 / warning red / ice fire / cyan red/special 2 / gradient red / gradient green/gradient blue / warning green/warning blue
Crosshairs :	Show (default), hide, move
Contrast Ratio :	Slider adjustment (0-255)
Brightness:	Slider adjustment (0-511)
DDE gear (image enhancement):	Off / On (default on)
Temperature measurement OSD on/off:	Off / On (the default displays the highest, lowest, and center point temperatures)
Temperature measurement unit :	Centigrade, Kelvin, Fahrenheit

Temperature measurement alarm :	Off, low-temperature alarm, high-temperature alarm, high and low-temperature alarm
Low-temperature alarm setting:	-20°C~+150°C
High-temperature alarm setting:	-20°C~+150°C
<b>Fixed Angle Camera (FAC)</b>	
Waterproof Rating:	IP67
Weight:	Approx. 85g
Size:	45*44*40mm
Image Sensor:	1/2.7" 2M SONY CMOS
Lens:	F2.2mm f/5.06, FOV: 130°
Burst Photo:	3/5/10 pcs
Video Resolution:	FHD: 1920*1080 30/60p, HD: 1280*720 120/60p
Max Video Stream:	30 Mbps
Photo Format:	JPEG
Video Format:	MP4 / MOV
Memory Card:	Micro SD CARDS with a maximum capacity of 128GB, write speed ≥ 30 MB/s, recommend using Class 10 or above & UHS-1 rating
Working temperature:	-10°C to 40°C
<b>Payload Release (PL1-S)</b>	
Waterproof Rating:	IP67
Weight:	59*38*50mm
Size:	96 g
Max loading weight:	2 kg
<b>Parachute (PTE4)</b>	
Size:	155*134*122mm
Weight:	500 g
Max. loading weight:	6 kg
Release:	Manual/Automatically
<b>Life Buoy (LB1)</b>	
Weight:	366 g
Size:	205*100*65 mm
Material:	Polyester Oxford neoprene
Airbag material:	Nylon+ TPU
Inflation Time:	less than 5s



Buoyancy:	73 N
Buoyancy time:	more than 48 hrs
Loss of buoyancy after 24 hours:	≤5%
Carbon dioxide weight:	3 / 8-24UNF, 24g
<b>Extension Bar</b>	
Weight:	138 g
Length:	40 cm
Material:	Carbon fiber tube & alluminum base
<b>Dronar 01 (Fish Finder)</b>	
Depth Range Max:	120 feet (40 m)
Depth Range Min:	2 feet (0.6 m)
Sonar Frequency:	125 kHz Single Beam
Cone Angle:	30°
Audible Alarms:	Fish, Depth, Low Battery
Working Temperture:	-20°C to 80°C
Transmission Distance:	10 m with phone; 3km with drone
Interface:	Dronar APP
Battery:	3600 mAh, 11.1 V; 39.96 Wh
Connection:	5Ghz Wi-Fi
<b>Water Sampling Kit</b>	
Weight:	56 g
Bottle Cap Finish:	30-400/410/415 Diameter: 30 mm Height: 9 mm
Bottle Size:	for standard 350 ml & 550 ml plastic water bottle
Material:	aluminium
<b>Meterage microSD Card</b>	

Aircraft diagram:

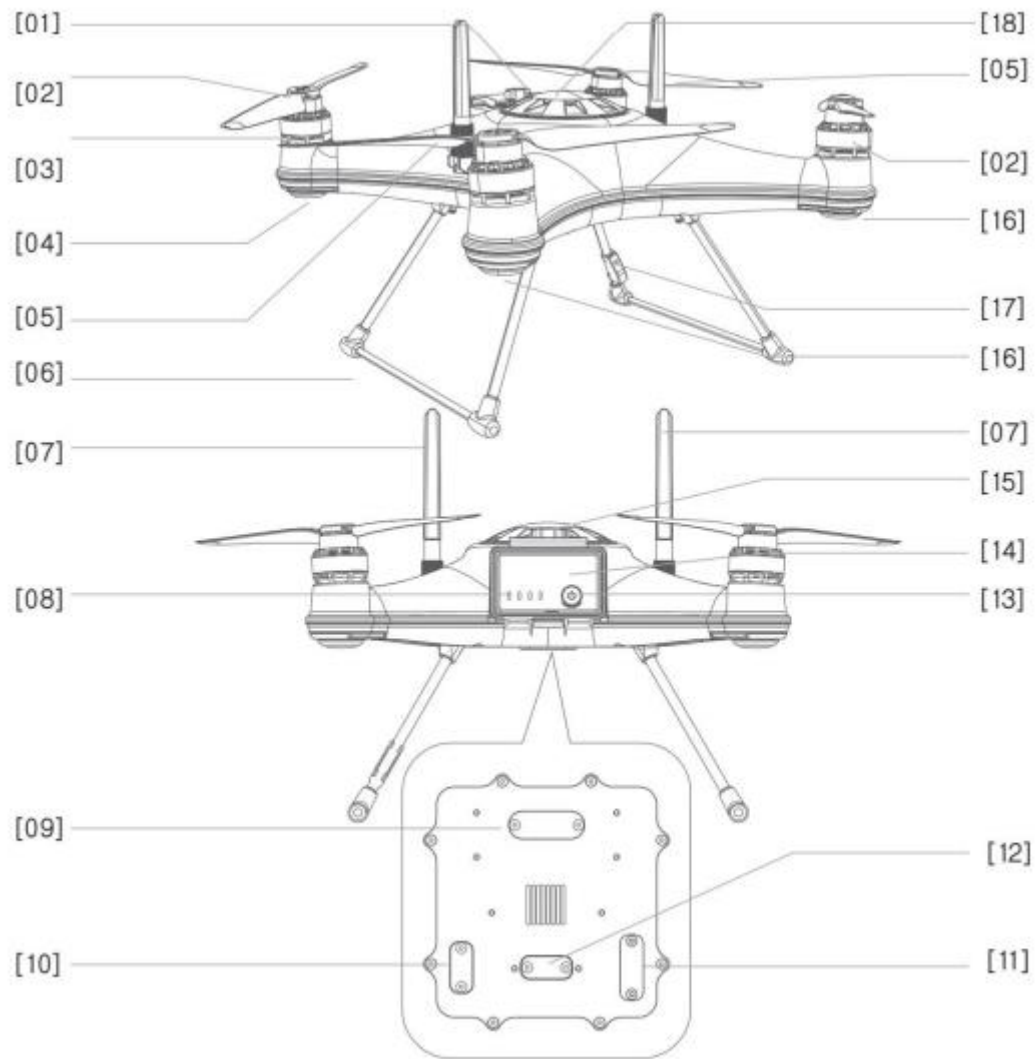

- [01] Strobe Light
- [02] CW (clockwise) Propeller
- [03] Waterproof Motor
- [04] Rear Arm Light
- [05] CCW (Counter-clockwise) Propeller
- [06] Landing Gear
- [07] Antennas
- [08] Battery Status Indicator
- [09] Gimbal Camera Port
- [10] Payload Release Port
- [11] SDK Port
- [12] USB Port and Pairing Button

- [13] Power Button
- [14] Battery Hatch
- [15] Battery Hatch Lock
- [16] Front Arm Light
- [17] Compass Sensor
- [18] GPS Cover

**Remote controller diagram:**

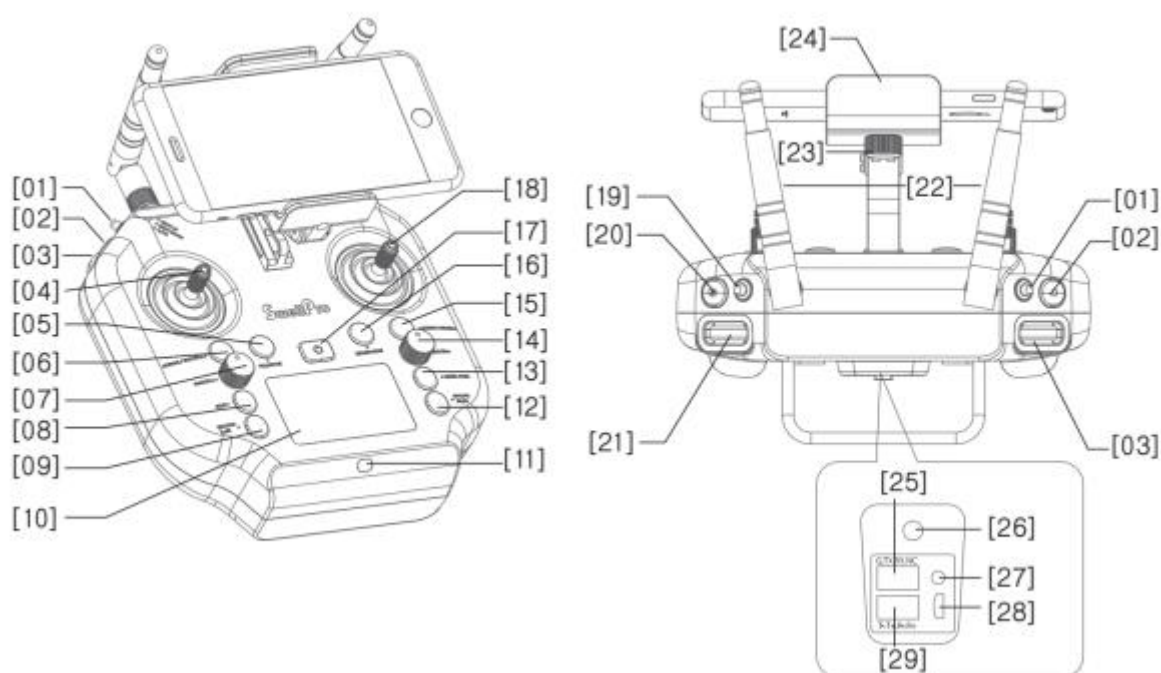

- [01] Automatic Landing Gear Toggle (Not Applicable)
- [02] Video Button
- [03] Gimbal Pan/Tilt Roller
- [04] Left Joystick (Throttle/Yaw)
- [05] Follow Me Button
- [06] Smooth+ Yaw Switch Button
- [07] Smooth+ Yaw Knob
- [08] Boat Mode Switch Button
- [09] Left Payload Release Button
- [10] Display Screen
- [11] Charging Indicator
- [12] Right Payload Release Button

- [13] Gimbal Mode Switch Button
- [14] Smooth+ Roll Knob
- [15] Smooth+ Roll Switch Button
- [16] RTH Return Home Button
- [17] Power Button
- [18] Right Joystick (Pitch/Roll)
- [19] Flight Mode Toggle
- [20] Photo Button
- [21] Gimbal Pitch Roller
- [22] Antennas
- [23] Phone/Tablet Mount Adjustment Knob
- [24] Phone/Tablet Mount
- [25] Serial Port
- [26] Charging Port
- [27] Pairing Button
- [28] Micro USB Port
- [29] Ethernet Port

## Remote controller screen

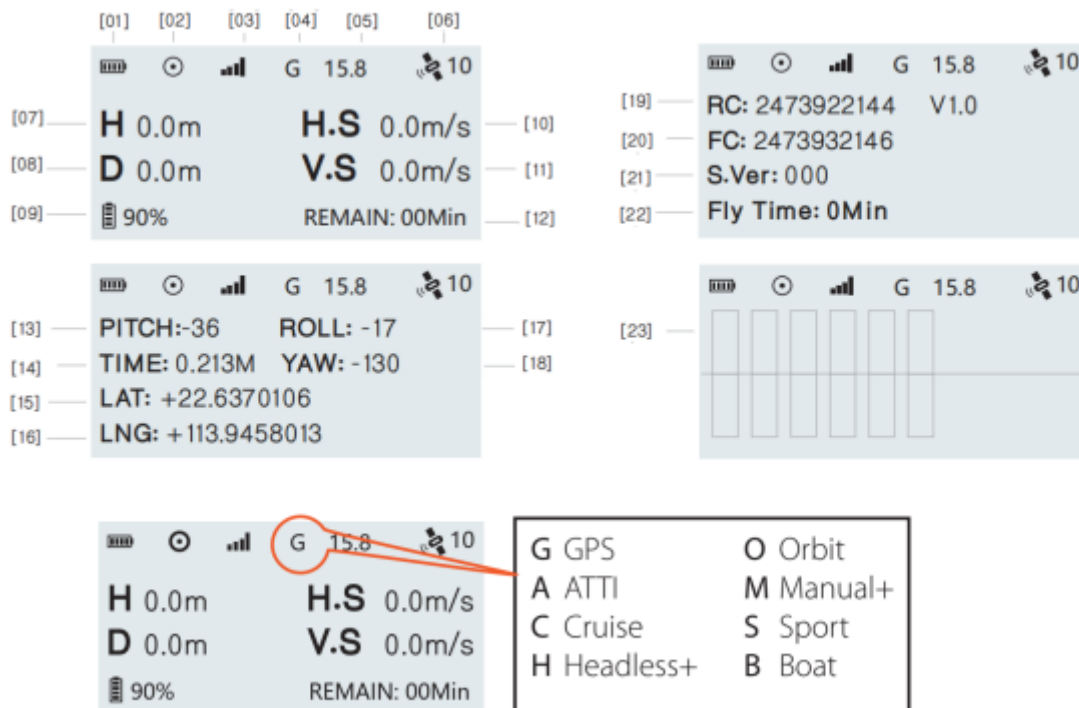

- [01] Remote Controller Battery Level
- [02] Remote controller GPS Signal \*1
- [03] Drone Signal Strength/Pairing Status
- [04] Flight Mode \*2
- [05] Drone Battery Voltage (V)
- [06] Drone GPS Location Accuracy \*3
- [07] Drone Height from Take-off Point
- [08] Drone Distance from Take-off Point
- [09] Drone Battery Level
- [10] Horizontal Flight Speed
- [11] Vertical Flight Speed
- [12] Estimated Remaining Flight Time
- [13] Pitch Angle
- [14] Flight Time
- [15] Drone Latitude \*4
- [16] Drone Longitude \*4
- [17] Roll Angle
- [18] Yaw Angle

[19] Remote controller Serial Number & Firmware Version

[20] Flight Controller Serial Number

[21] Flight Controller Firmware Version

[22] Total Flight Time

[23] Joystick and Control Input

#### Notes.

1. A flashing GPS Location Fix icon [02] indicates that the remote controller does not have a current location fix. This does not relate to the drone's GPS accuracy.

2. Flight Modes: G: GPS mode, A: ATTI mode, S: Sport mode, O: Orbit mode, H: Headless mode, C: Cruise mode, M: Manual mode ©2021 Sprinkle Pro All Rights Reserved 11

3. Drone GPS Location Accuracy ranges from 1-10 with 10 being the highest accuracy. A rating of 10 indicates a drone location accuracy

### Install the aircraft:

#### Install Propellers

The Sprinkle Drone 4 has two pairs of propellers - two clockwise propellers and two counter-clockwise propellers. The hub of each motor shows the type of propeller used for that motor. Propellers should not be attached to the wrong motors.

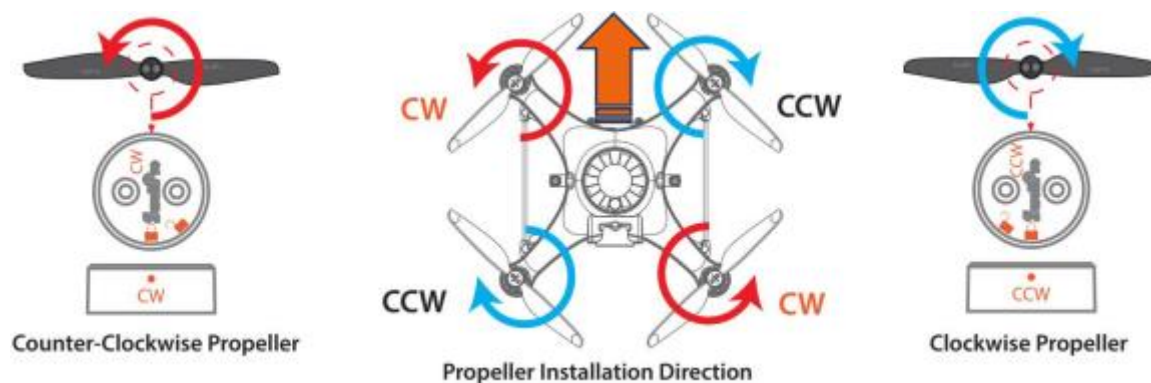

#### To install or remove propellers:

1. Check the propeller's marking (CW/CCW) to see if it matches the motor. CCW propellers to CCW motors, same for CW.
2. Place the propeller on the motor, rotate the propeller in the hub for 1/8th of a turn until it engages.
3. Hold the arm of the aircraft tight with one of you hand.
4. Rotate the propellers in the direction indicated by the lock signs with your other hand.
5. To remove the propeller, repeat steps 3&4.

#### Install the Intelligent Battery:

The Intelligent battery is quick and easy to change. Ensure the battery is OFF before inserting or removing it from the drone.



1. Unlock and open the waterproof hatch
2. Slide in the fully charged intelligent battery and push it firmly into the battery slot.
3. Close the battery hatch. Fasten the catch and then lock the hatch.

Install the Camera/Accessories:

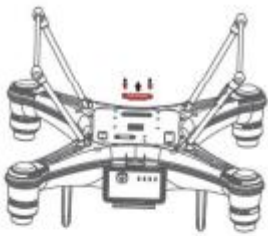

1. Unscrew and take off the gimbal port cover plate using a hex screwdriver. (Equipped with Sprinkle Drone 4)



2. Plug the gimbal connector into the drone's gimbal port and screw it in place with a screwdriver. Make sure the rubber ring is attached to the gimbal connector before you screw the connector.



3. Aline the holes on the base of the gimbal to the bottom of the drone, screw in to mount the gimbal. Make sure the camera is pointing to the front of the drone

### 3. AIRCRAFT

#### Aircraft Status Indicator

There are two types of aircraft status indicators:

1. Front status indicators (Red).
2. Rear status indicators (Green).

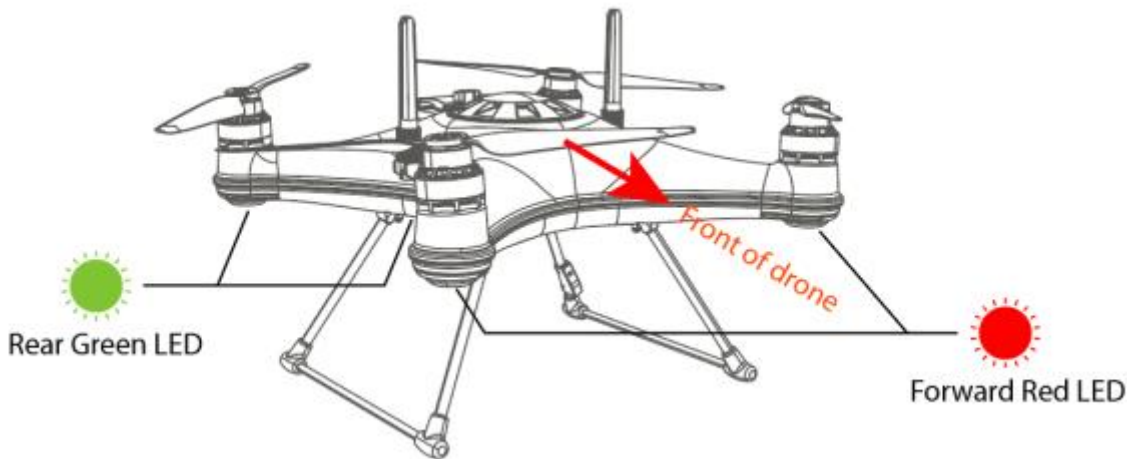

- The red status indicators are used to identify the head of the drone.
- All aircraft status indicators can be turned on or off on the App setting.
- All the status indicator messages are going to prompt on the remote controller screen.

GPS Status		
	Solid Green	Good GPS signal
	Fast Flashing Green	Poor GPS signal

Low Battery Warning		
	Flashing Red 4 times	First low battery warning
	Fast Flashing Red	Second low battery warning
	Flashing Red 3 times	Auto returning home

Calibration Warning		
	Red Green Slow Flashing Together	Compass calibration required
	Fast Flashing Green	Rotate aircraft horizontally
	Slow Flashing Green	Rotate aircraft vertically
	Red Green Slow Flashing Together	Gyroscope calibration required
	Red Green Slow Flashing Together	IMU calibration required
	Red Green Flash Alternatively	Aircraft initializing



**Intelligent Battery:**

Each slide-in Sprinkle Drone 4 battery has its battery management system, teamed with high-performance 18650 lithium cells to provide up to 30 minutes of flight time.

The Sprinkle Drone 4 intelligent battery provides:

- Real-time power monitoring and alerting
- Integrated balance charging to ensure battery health, safety, and long life by constantly monitoring battery health, state-of-charge, and temperature.
- Fast, slide-in battery replacement. Integrated connectors allow for wire-free installation and replacement.
- Battery charging and usage data logging to allow for better battery management and event recording.

**Battery Level :**

The battery level LEDs on the battery pack allow you to check the state of charge of the battery quickly and accurately.



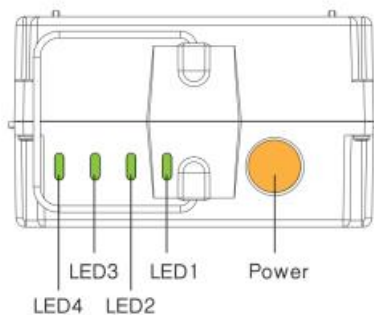













With the Battery turned OFF, short press the power button – the battery LEDs will indicate the state of charge.



LED1	LED2	LED3	LED4	Battery Level
Solid	Solid	Solid	Solid	88~100%
Solid	Solid	Solid	Flashing	76~87%
Solid	Solid	Solid		63~75%
Solid	Solid	Flashing		51~62%
Solid	Solid			38~50%
Solid	Flashing			25~45%
Solid				13~25%
Flashing				0~12%

 Solid
  Flashing

**Battery Warning Signs:**

LED1	LED2	LED3	LED4	Battery Warning Type
				Battery Overvoltage Warning
				Battery Undervoltage Warning
				Battery Overcurrent Warning
				Battery Overheating Warning



Flashing

**Powering On/Off the Battery:**

Shortly press the power button once(battery will beep once), then long press the power button for three seconds, battery will beep twice to indicate the battery is turned on. Same for powering off the battery.

**Charging the Batteries:**

Your Sprinkle Drone 4 is shipped with partially charged batteries. Ensure the drone battery and the remote controller battery are fully charged before use.

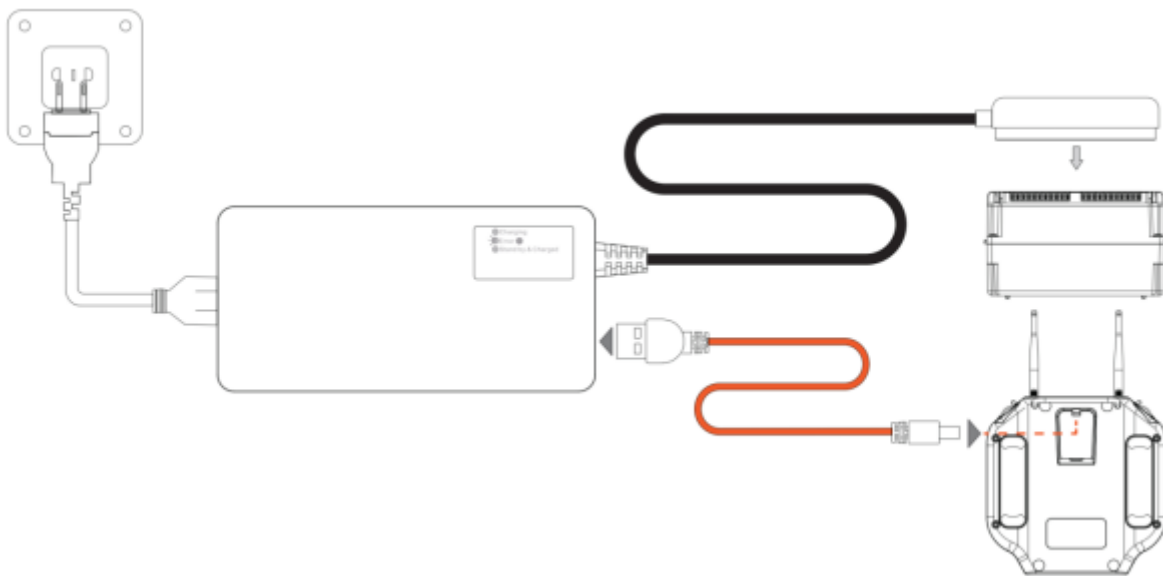

The drone and remote controller batteries can be charged simultaneously using the in-the-box charger.

### How to charge:

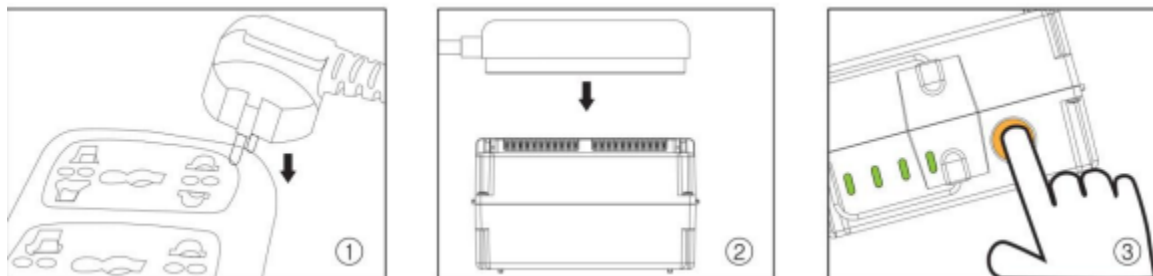

Refer to the above figures to connect the intelligent battery and charger. Press the power button to turn on the intelligent battery, and the battery will enter the charging state

### Low Battery Warning:

The Sprinkle Drone 4 has two low battery warnings to help the pilot manage the drone's battery life. Each time a battery level alarm is activated, the remote controller will beep and vibrate to alert the pilot.



Level 1 alarm: The drone battery level has reached 13.0 V. The remote controller screen will prompt "LOW BATTERY; Return Aircraft and Land". The front drone status indicators will flash a pattern of 4 red lights. If low battery auto Return-toHome is turned on, the drone is



Level 2 alarm: The drone battery level has reached 12.0 V. The remote controller screen will prompt "AIRCRAFT BATTERY LEVEL CRITICAL; Land Aircraft NOW". After 10 seconds, the drone will initiate an in-place auto-landing to protect the drone and battery. The

During auto-landing, you can control the joystick to overwrite the auto-landing and regain control of the drone. However, flying the drone below 12V is highly dangerous since the battery will not be able to maintain the flight and will result in the aircraft crashing.

### **Aircraft Antenna:**

The antennas of the drone can be oriented either upwards or downwards to maximize reception in different situations. The Sprinkle Drone 4 has an effective range of 5 km. Due to the way radio frequency travel, when flying 0.5m above the water, the transmission range reduces to 2.8 km. For the drone floating on the water surface, the transmission range reduces to 500m. Generally, upward-pointing antennas improve reception when the drone is floating or flying close to the water surface. Orienting the antennas downwards maximizes range for higher altitude flights. Adjust the antennas' orientation to maximize range for your flight plan.



Antenna oriented upward: Improves reception when the drone is floating (boat mode) or flying close to the water surface.



Antenna oriented downwards: Improves reception when the drone is flying further away or fly at a high altitude.

To adjust the antenna position: loosen the antenna nut, adjust the antenna position, and retighten the nut.

### **Strobe Light:**

The top of the aircraft is equipped with high-intensity strobe light, which helps identify the drone's position to the pilot and other air traffic. This meets the requirements of night flight regulations in some countries and helps ensure flight safety at night. The strobe can be activated and deactivated in the App (STB).

### **Waterproof Barometric Membrane:**

The waterproof barometric membrane is Sprinkle Pro's featured technology. It allows air to pass through the internal chamber of the aircraft to ensure the barometer's proper functioning yet keeps the water from getting in to ensure the Sprinkle Drone 4's all waterproof design. The waterproof barometric membrane is delicate yet an extremely important part for proper flying and waterproofing. Therefore, you should pay special attention to the proper use of waterproof barometric membrane during your operation.

- Always check the waterproof barometric membrane to ensure no damage being observed before flying.
- Rinse the waterproof barometric membrane thoroughly with freshwater every time after flying.
- If you constantly fly your drone in the saltwater environment (sea), it is recommended to change the waterproof barometric membrane once every 2 months, since the salt particles can clog the tiny holes on the membrane.

If the aircraft is not flying stably during hovering, or the aircraft is not flying normally during ascend or descend, the waterproof barometric membrane might be damage. Please take off the top barometric membrane cover and replace the waterproof barometric membrane. If the waterproof barometric membrane is damaged or shows signs of wear and tear, replacement of the waterproof barometric membrane is required. To replace the waterproof barometric membrane:

1. Take out the top cover.
2. Peel off the old waterproof barometric membrane. Clean the surface barometric vent and make sure there is no residue on the surface.
3. Remove the 3M paper from the waterproof barometric membrane and press it firmly on the barometric vent to ensure a tight seal.
4. Put the top cover back.

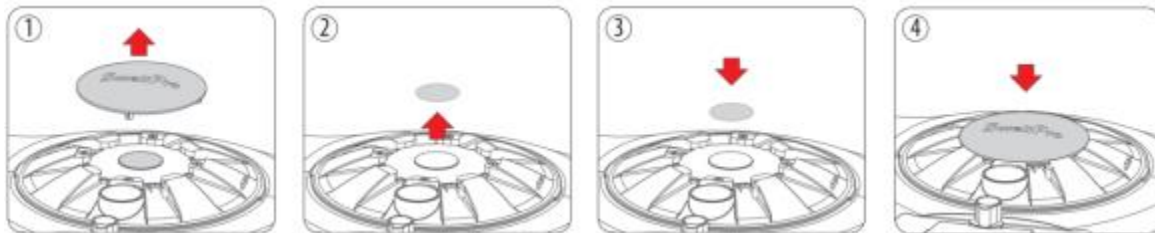

#### **4. REMOTE CONTROLLER:**

Using the Remote Controller:

Note: Install the Remote controller antennas BEFORE using or turning the power on.

Failure to install the antennas before powering on the remote controller may cause permanent damage to the remote controller. Failure to install the antennas before using may cause antenna ports to oxidate

### Power ON/OFF:

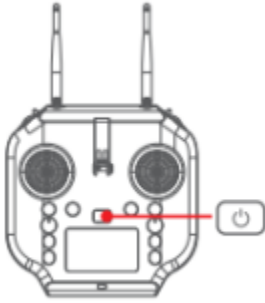

1. Press and hold the Power switch for 3 seconds.
2. The Remote controller will power ON.
3. To turn OFF the Remote controller, return the Camera Control switch to the Preview position to stop any recording.
4. Press and hold the Power switch for 3 seconds. The Remote controller will power OFF.

### Flight Mode Switch:

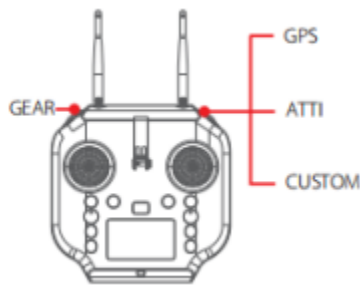

- GPS: Sets the drone to GPS mode. ATTI : Sets the drone to ATTI mode. CUSTOM: Sets the drone to the user-selected flight mode. This can be set in the App. The default flight mode is Sport mode. GEAR: Not currently supported.

### Joystick Controls:

LEFT JOYSTICK controls Throttle & Yaw; RIGHT JOYSTICK controls Pitch & Roll. YAW controls the direction; THROTTLE controls the ascend or descend of the drone; PITCH controls the drone to fly forward or backward; ROLL controls the drone to fly left or right.

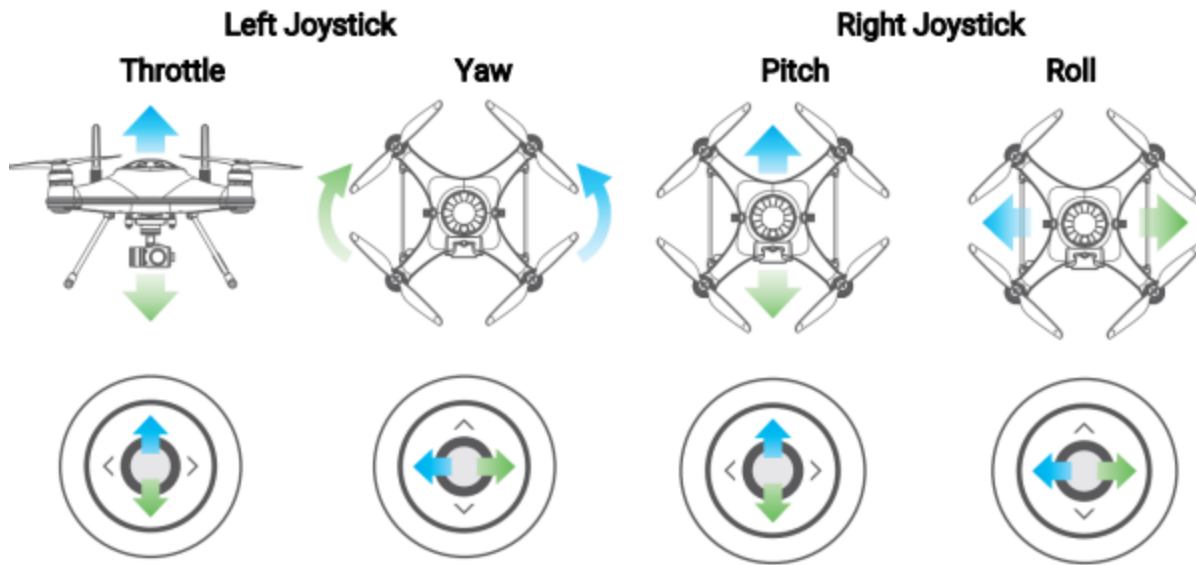

**Camera Control:**

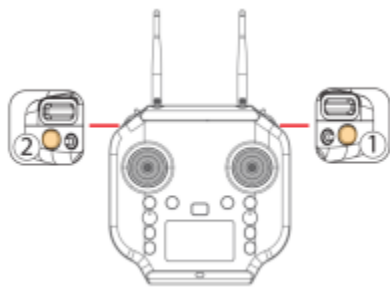

Photo①: Press the photo button to capture photos.  
 Video②: Press the video button once to start video recording. Press again to stop video recording and save the video file. It is important to stop video recording before powering off the drone.

**Gimbal Control:**

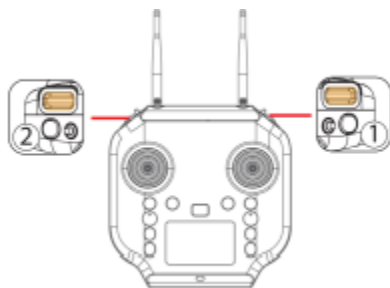

Tilt Control Roller①: Control the tilt angle of the gimbal. Pan Control Roller②: Control the direction of the gimbal.

**Follow Me:**

Start Follow Me: Check that the remote controller has a GPS lock by checking the GPS status indicator on the screen. Press and hold the Follow Me button ① to start Follow Me mode. The remote controller will beep twice.

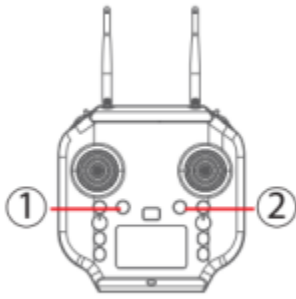

Stop Follow Me: Press and hold the "FOLLOW ME" button again until the remote controller beep once to indicate that Follow Me mode is disengaged.

**Return to Home (RTH):**

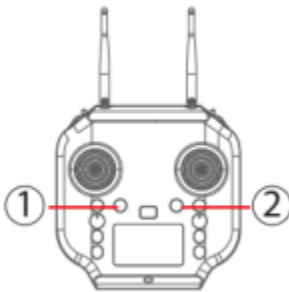

Long press the Return Home button ②, the remote controller will beep and vibrate twice to indicate that the drone will initiate the return to home process. The flight mode indicator on the remote controller status bar will change to the letter "R" to indicate the drone is on the RTH process.

**Smooth+ Controls:**

The patented "Smooth+" flight control allows the pilot to finely tune the Roll and Yaw of Sprinkle Drone 4. Smooth+ makes professional, steady flight control as easy as turning the knobs.

To enter Smooth+ mode, simply press the Smooth+ buttons. Note: Smooth+ knob need to be in the center position in order to be turned on.

Press the left Smooth+ button to engage Smooth+ YAW. The left joystick will now only control the ascend/descend of the drone.

Press the right Smooth+ button to engage Smooth+ ROLL. The right joystick will now only control the pitch of the drone.

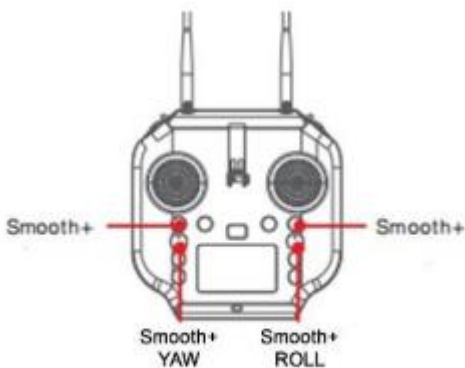

**BOAT Button:**



In Boat mode, the Sprinkle Drone 4 can effectively be controlled like a boat on the surface of the water. With a maximum surface speed of 1m/s. BOAT mode should only be used when the aircraft is equipped with the Sprinkle Pro Boat Mode Kit (BKT).

To enter the Boat mode:

1. Land or place the drone on the water.
2. For landing on the water, lock the drone.
3. Switch the drone to GPS or ATTI mode.
4. Arm the drone by using the inward gesture.
5. Press the BOAT button on the remote controller.
6. The drone now enters the Boat mode.
7. Press the BOAT button again to exit Boat mode. The drone can then take off normally

### **Gimbal Button:**

There are two gimbal modes: Follow mode and Lock mode. The default mode is Follow mode.

Follow mode keeps the gimbal direction to the head of the drone.

Lock mode locks the gimbal position so the is not going to follow the direction of the drone when the drone is turning.

Press the GIMBAL MODE button once to restore the central position.

Press the GIMBAL MODE for 3 seconds to switch gimbal modes.

Gimbal mode only works for GC3-S and GC3-T. You can add an extension bar or gimbal overhead kit to take full advantage of gimbal Follow mode and Lock mode.

### **Payload Button:**

There are two PAYLOAD buttons on the remote controller, the PAYLOAD(Left) and PAYLOAD(Right). But for the Sprinkle Drone 4, only the PAYLOAD(Left) is used for payload release control. The PAYLOAD(Right) is used to configure the drone to low speed mode.

Press and hold the PAYLOAD(Left) button to open the payload release rod. Release the PAYLOAD(Left) button to close the payload release rod.

Press the right PAYLOAD button 3 times to enter low-speed mode. There is a low-speed mode embedded in all flight modes for a safer flight purpose. (For example, when the drone is equipped with Sprinkle Pro Gimbal Extension Bar (GEB), switching to low-speed mode allows the drone to fly more stable and safely.)

### **Remote Controller Rear Ports:**

- ① SDK Serial Port: access to flight control data and transparent transmission.
- ② Charging Port: remote controller charging port.
- ③ Pairing Button: used for aircraft and remote controller pairing.
- ④ Micro USB: use for remote controller firmware upgrade.
- ⑤ Ethernet Port: This supports the development of computer ground station software to control the aircraft and its airborne equipment.

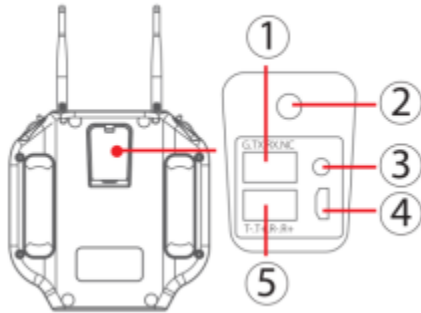

**Attach Mobile Devices:**

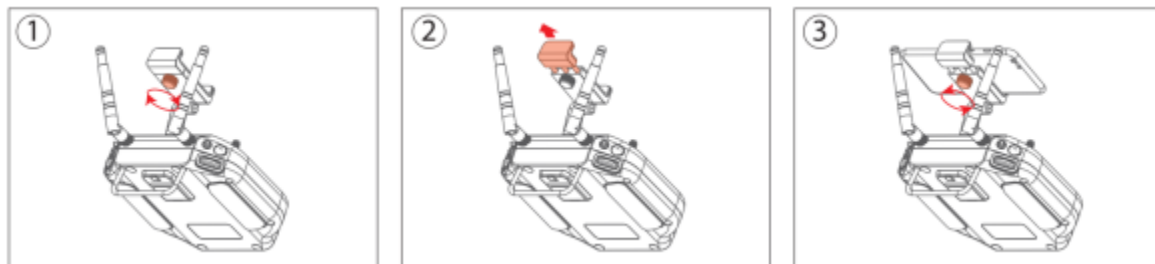

To attach your mobile device to the remote controller: Release the tightening knob behind the mobile device mount, then slide open the mount to accommodate your device, retighten the knob to secure your mobile device.

- There is a larger mobile device mount specific designed for the use of tablets. Visit Sprinkle Pro website for more information.

**Charging the Remote Controller:**

The remote controller can be charged from the in-the-box charger or a standard 5V USB adapter. Recommend using 5V/2A USB adapter.

The LED light on the remote controller will turn red while charging. When the remote controller is fully charged, the LED light will turn off.

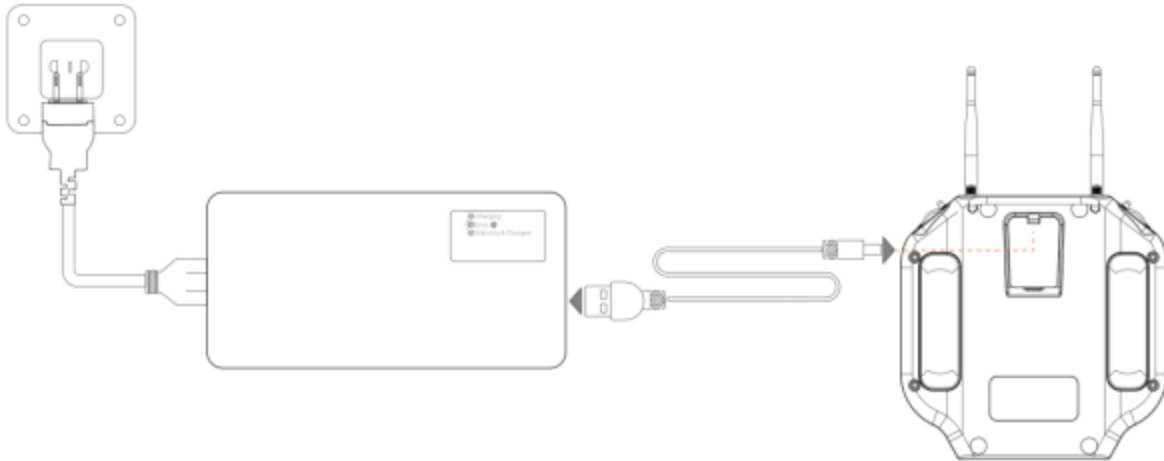

### Pairing the Remote Controller:

The remote controller and the aircraft are paired on the factory before shipping. There is no need to pair them on your first use.

- ONLY pair the remote controller for the following condition: After powering on the drone and the remote controller for more than two minutes, the remote controller signal status bar still shows the Unpair sign as shown below.

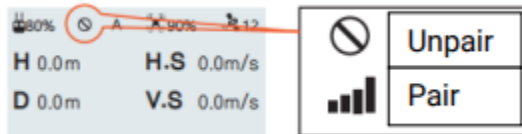

Proceed to the following steps to re-pair:

1. Power on both the aircraft and the remote controller.
2. Unscrew and take off the "USB/Pairing Button" plate.
3. Wait for 1 minute, long press the pairing button of the aircraft for over 5 seconds. Double click the remote controller pairing button.
4. The pairing is going to finish in 2 minutes. Repeat the steps when the pairing failed.



Note: pair button is a delicately part of the electronic board. Press the pair button gently to prevent unexpected damage to the button.

Reset Image Transmission:

If the pairing process does not succeed, you might need to reset the image transmission of the aircraft.

Look for the SN number inside of the battery chamber.

**To reset the image transmission:**

1. Power on the aircraft.
2. You need to disassemble the aircraft's aluminum base. Screw off the hex screws holding the base.
3. Uncover the aircraft base, you can find the image transmission board. Look for the "Reset Key" as shown below.
4. Long press the "Reset Key" for 10 seconds to reset the image transmission board. (Note that you need to power on the aircraft for 1 minute before you press the "Reset Key")
5. Wait for 1 minute for the image transmission to process resetting.
6. Then you can proceed to the pairing process to re-pair the aircraft and the remote controller.
7. Screw back the aluminum base back to the aircraft.

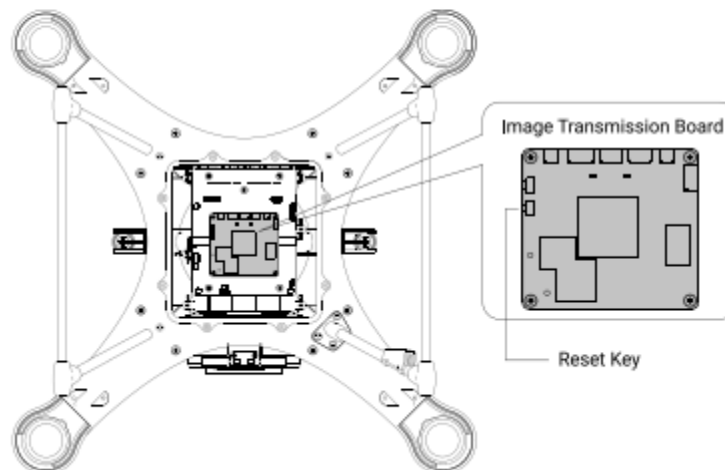

To reset the image transmission:

1. Power on the aircraft.
2. Unscrew and take off the "USB/Pairing Button" plate. There is no need to take off the whole aluminum base.
3. Long press the "Pairing Button" for 10 seconds to reset the image transmission board. (Note that you need to power on the aircraft for 1 minute before you press the "Pairing Button")
4. Wait for 1 minute for the image transmission to process resetting.
5. Then you can proceed to the pairing process to re-pair the aircraft and the remote controller.
6. Screw back the "USB/Pairing Button" plate to the aircraft.

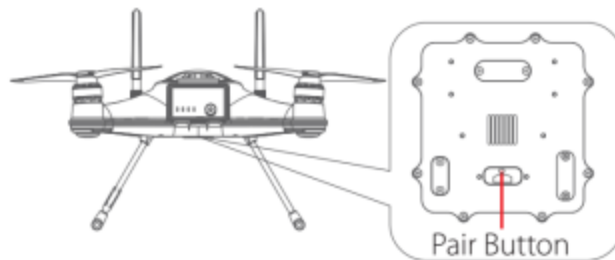

## 5. FLIGHT

The drone relies on sensitive sensors to control flight positioning and stability. The Sprinkle Drone 4 is flight tested before shipment, however, an initial calibration of the compass is required for your first use.

- Before operating the drone from a ship or other moving platform, ensure all necessary calibrations have been completed before aboard, as some calibrations require a completely stable platform.

### **Flight Safety and Environment**

- Please make sure you have a comprehensive understanding of the Sprinkle Drone 4, and all the necessary measures required to implement a successful return home function in the event of an emergency.
- If this is your first time flying a drone, please read this manual thoroughly and watch the tutorial videos on our website [www.Sprinkle Pro.com](http://www.Sprinkle Pro.com), or our YouTube channels.

- We recommend taking professional training and guidance. When flying, choose an appropriate environment according to your skills. Check all calibrations and choose a large open area to practice.
- It is recommended for all drone pilots to become familiar with flying in ATTI mode in case of GPS or magnetic interference, which may result malfunction when flying on GPS mode.
- Please be well prepared before each flight, avoid any violent or excessive operations.
- Please maintain strict compliance with the local laws, any flying in NO-FLY ZONES is prohibited.
- Any illegal & improper use or operation of this product is prohibited.
- Any invasion & violation of another person's right to privacy is not allowed. Before using this product, it remains the duty of the drone pilot to comply with the local laws regarding privacy protection.
- Any invasion or flying over another person/s property is not allowed, please agree with any persons regarding any potential breach of privacy before the proposed flight.
- DO NOT fly the Sprinkle Drone 4 under the influence of alcohol, drugs, or any other physical or mental impediment.
- Do not fly the drone with a malfunctioning remote controller.
- Please fly the drone away from crowds

**Flight environment requirement:**

- Always choose the open space as an ideal flying environment.
- Flying between or near tall buildings could adversely affect the functioning of the compass and adversely affect or block GPS and transmission signals.
- During the flight, try to maintain the line of sight with the drone, keep away from obstacles and people.
- Avoid flying near areas with high electromagnetic interference such as power lines or signal towers to minimize the risk of interfering with the remote controller of the drone.
- Fly below 4000 meters above sea level as environmental factors including air density and wind shear reduce the performance of the aircraft and battery.
- Before flying in low temperatures, warm the battery to ~25°C to maximize flight time.
- Although the Sprinkle Drone 4 is waterproof, do not fly in fog or strong wind conditions. (For wind speed exceeding 14 m/s, or above Beaufort Force 6)

## Restricted Area



Airport



Crowds

## Threats to Flight Safety Scenarios



Radio signal tower



Radar



High voltage power lines



Trees



Tall buildings

## Flight Restrictions:

According to provisions of the International Civil Aviation Organization and many national air traffic regulations, drones must be operated in specified airspaces. By default, the Sprinkle Drone 4 is configured to not exceed an altitude of 120m the Home Point altitude.

- If you need to cancel the height limitation, please set the flight altitude to 0 through the Fly App.

## Pre-Flight Checklist

- Intelligent batteries, remote controller, and your mobile devices are fully charged.
- Check all propellers are in good condition and correctly installed.
- Manually rotate the 4 motors to ensure they can spin smoothly.
- Make sure the waterproof barometric membrane is not damaged.
- Make sure all the connector sealings are tightly sealed with the rubber rings attached, include the battery sealing, all the base connector ports. Make sure the sealings are free of dirt, sand, and other debris.
- All the payload modules are tightly mounted to the aircraft.
- Micro SD card has been inserted and tightly sealed.
- Fly App is successfully connected to the aircraft.
- Check the following flight data: flight battery > 16.0V; remote controller battery > 1 bar; Satellite > 5.

## Compass Calibration

Compass calibration is necessary for any of the following situations:

- The drone is brand new.
- The drone has been repaired.

- The drone has been subjected to strong magnetic fields.
- The drone has been crashed or subjected to heavy shaking.
- The drone sways or drifts excessively during hovering in GPS mode.
- The drone is more than 100 km away from the last calibration location.
- The drone is not able to fly straight.
- The drone is flying to a certain direction when there is no input from the remote controller.
- The remote controller screen prompts "WARNING Compass error Calibrate Compass".

### Compass Calibration Process:

- Place the drone on a level surface, power on the remote controller then the drone. Wait for the aircraft to connect to the remote controller.
- After the connection finishes, fast switch the Flight Mode toggle back and forth until the aircraft's rear status indicators flash green, or the remote controller screen prompts "Compass Calibration Rotate the Aircraft Horizontally". The drone will now perform compass calibration. 3. Pick up the aircraft and hold the drone horizontally and rotate clockwise about 2~3 turns until the rear indicators slowly flash green or the remote controller screen prompts "Compass Calibration Rotate The Aircraft Vertically".
- Hold the drone nose-down and rotate clockwise about 2~3 turns until the remote controller screen prompts "WARNING Aircraft Initializing, Please Wait".
- Place the drone on a level surface for 30 seconds. When the prompt disappears, power off and restart the drone.
- The compass calibration is complete.



- Compass calibration needs to be performed outdoors in an open area.
- Remove propellers before calibration.
- Perform the calibration process away from sources of magnetic fields, such as large metal structures, radio signal towers, power lines or mobile phones, etc.

### Gyroscope Calibration:



The gyroscope provides stability data to the flight controller. If the gyroscope is not well calibrated, the aircraft will tilt to one side when it takes off, and the tilted angle will increase until the aircraft can no longer fly.

Process gyroscope calibration for the following situations:

- The drone trembles significantly during hovering in GPS mode.
- The drone's tilt range is too large during ascending in ATTI mode.
- The drone drifts during ascending or descending in GPS mode.
- The drone has been crashed or subjected to heavy shaking.
- The remote controller screen prompts "WARNING Gyroscope error Calibrate Gyroscope".

#### **Gyroscope Calibration Process:**

- Place the drone on a level surface, power on the remote controller, then the drone. Wait for the aircraft to connect to the remote controller.
- Hold the left joystick down to its lowest position, then quickly move the right joystick left to right, back and forth, until the front and rear status indicators flash alternately, or the remote controller screen prompts "WARNING aircraft Initializing, Please Wait". The drone will now perform gyroscope calibration. Now release the joysticks. This process will be completed in 20 seconds. Do not move the drone during this process.
- When the front status indicators turn solid red and the rear status indicators turn solid green, or "WARNING Aircraft Initializing, Please Wait" prompt disappears, power off and restart the drone. Gyroscope calibration is complete.

#### **Note:**

- Never calibrate the gyroscope on a boat or other moving platforms.
- When the drone is floating on water, it may occasionally prompt gyroscope calibration, which is normal and can be ignored.
- If the calibration fails, the "WARNING Aircraft Initializing, Please Wait" prompt will not disappear, please follow the steps, and try to calibrate again.



### **IMU Calibration:**

The Inertial Management Unit (IMU) provides the raw data of the aircraft's attitude in space in nine dimensions. The IMU accelerometer sensor is critical to balance the aircraft in flight.

Proceed IMU calibration for the following situations:

- The drone cannot arm (unlock) the motors after the compass calibration.
- The drone sways or drifts excessively during hovering in GPS mode.
- The drone has been crashed or subjected to heavy shaking.
- The remote controller screen prompts "WARNING IMU error - Calibrate IMU".

### **IMU Calibration Process:**

- Place the drone on a level surface, power on the remote controller, then the drone. Wait for the aircraft to connect to the remote controller.
- Hold the left joystick up to its highest position, then quickly move the right joystick left to right, back and forth, until the front and rear status indicators flash alternately, or the remote controller screen prompts "WARNING aircraft Initializing, Please Wait". The drone will now perform IMU calibration. Now release the joysticks. This process will be completed in 20 seconds. Do not move the drone during this process.
- When the front status indicators turn solid red and the rear status indicators turn solid green, or "WARNING Aircraft Initializing, Please Wait" prompt disappears, power off and restart the drone. IMU calibration is complete.



**Note:**

- Never calibrate the IMU on a boat or other moving platforms.
- When the drone is floating on water, it may occasionally prompt IMU calibration, which is normal and can be ignored.
- If the calibration fails, the "WARNING Aircraft Initializing, Please Wait" prompt will not disappear, please follow the steps, and try to calibrate again.

**Basic Flight Steps:**

1. Check that the aircraft is correctly assembled.
2. The propellers are correctly mounted and secure.
3. The battery hatch is closed and locked.
4. The silicone plug on the back of the remote controller is closed.
5. The mobile device is securely mounted to the remote controller.
6. Place the aircraft on flat open ground or water.
7. Power on the remote controller, followed by the drone.
8. Connect the mobile phone to the remote controller Wi-Fi.
9. Open the App and wait for the camera image to Appear and the flight data display is normal.
10. Check the following flight data: flight battery > 16.0V; remote controller battery > 1 bar; Satellite > 5.
11. For your safety, you should stand upwind and at least 3 meters away from the drone.
12. Novice pilots should always take off in GPS mode.
13. Arm the drone or use the auto take-off on the App.

14. Push the left(throttle) joystick up slowly, allowing the drone to take off smoothly. Release the throttle when the drone is Approximately 1.5 m high. Allow the drone to hover for a moment to ensure flight stability.

15. When you need to descend, gently pull down the left(throttle) joystick, allowing the drone to descend and land on a flat surface or the water.



16. After landing, keep the left(throttle) joystick down to its lowest position for 3 seconds until the motors stop, or you can use the disarm joystick command to stop the motors.

17. Stop video recording before shutting down the drone, otherwise, the video file may be damaged.  
Starting/Stopping Motors (Arming the Drone)

Before starting the drone, take the following precautions:

- Place the aircraft in an open area 3 meters away from yourself and others. After the aircraft is powered on, the system will conduct self-checking. After the self-checking is completed, it will sound a confirmation tone.
- Novice user should fly in GPS mode.
- If the aircraft cannot be unlocked due to weak GPS signal, switch to ATTI mode to unlock the aircraft. However, it is not recommended for novice pilots to fly in this mode, as the location of the drone is not fixed when flying in this mode.
- In Custom mode, the motors cannot be unlocked in Cruise, Orbit, Headless mode.

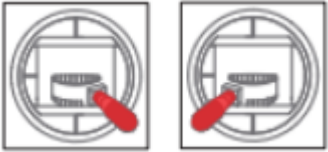
### Starting (Arming) Motors:

Remote Controller Operation	Description
	<p>Pull both the left and right joysticks simultaneously down and inwards and maintain this position for 3 seconds. The motors will be unlocked and start rotating.</p>
	<p>Method 1: After the aircraft has landed on the ground or water surface, pull the throttle to the lowest position, and hold for 3 seconds. The motor will be lock and stop rotating. The recommended method for stopping motors.</p>

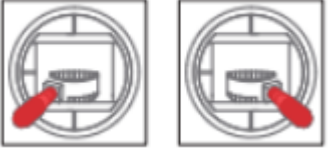
	<p>Method 2: Pull both the left and the right joysticks downwards and outwards. This method can be used as an emergency stop.</p> <p>Stopping the motors in flight may cause the drone to crash and should only be carried out in an emergency when stopping the motors will minimize potential damage. (For example, there is a risk that the drone may hit people or crowds)</p>
---	--

### **Water Takeoff and Landing:**

1. When taking off from choppy water, ascend quickly from the surface to prevent the drone from being affected by a passing wave.
2. When landing on water, descend vertically to the surface. If the drone lands with horizontal speed, it may flip and be inverted. The flight controller will shut down the motors if the drone becomes inverted on the water.

⚠ Do not leave the drone floating inverted for more than a few minutes. Flip the drone using the Power-Flip command or recover the drone as soon as possible to avoid water saturating the waterproof barometric membrane.

### **Boat Takeoff and Landing:**

When takeoff or landing from the boat/kayak, PAY EXTRA ATTENTION to the operation, as it can be very difficult and dangerous to operate the aircraft.

- There should be enough space for the drone to take off or land on the boat.
- If there is not enough space on the boat, take off and land on the water can otherwise be a safer, alternative option, as there is sufficient space for the drone to operate
- When the boat is rocking, the drone may not arm its motors in GPS mode. In this case, carefully take-off in ATTI mode and then switch to GPS mode if the satellite signal is back to.
- Always be aware of the direction of the wind relative to the boat for take-off and landing. Stand in the upwind position relative to the aircraft to prevent the aircraft from drifting toward you when take-off or landing in windy conditions.
- The Smooth+ controls are useful to finely control and balance the drone position during this operation.
- For your safety, it is not recommended to launch or land the Sprinkle Drone 4 from your hands.
- After initiate return-to-home on the boat, always regain control and land manually when the aircraft is approaching near you.

### Power Flip:

If the drone becomes inverted on the water, the Power-Flip feature enables the drone to flip back to its upright position.

When the drone floating upside-down on the water, pull both the left and right joysticks simultaneously down and inwards and maintain the control until the drone flip over to its upright position.

Power Flip feature is not applicable when the aircraft is equipped with the Boat Mode Kit (BKT).

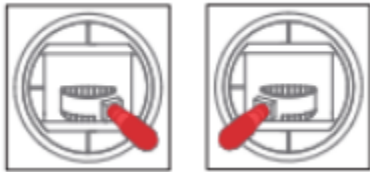

### Flight Modes:

There are 7 flight modes to configure on the Sprinkle Drone 4 to accommodate the different flight preferences and needs. They are GPS mode, ATTI mode, Sport mode, Orbit mode, Cruise mode, Headless mode, Manual mode, and Boat mode.

#### For GPS mode and ATTI mode:

GPS mode and ATTI mode can be set by simply switch the flight mode toggle on the remote controller.

#### For Sport mode, Orbit mode, Cruise mode, Headless mode, Manual+ mode:

Switch the flight mode toggle to Custom mode, then turn to the Fly App and set the flight mode among these 5 modes on the App flight mode section.

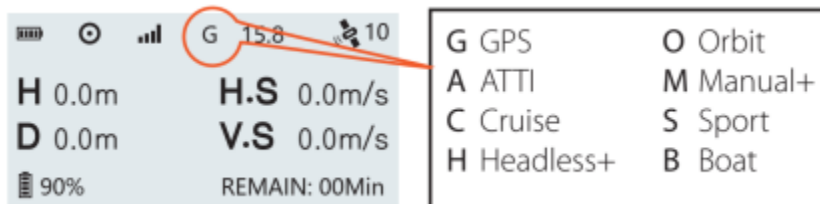

Flight Modes	Letter	Description
GPS	G	In GPS mode, the drone maintains a fixed position and height while hovering (with no input from the remote controller). The maximum flight speed is 10 m/s.
ATTI	A	In ATTI mode, the drone maintains a fixed height but not a fixed position. Therefore, when there is no input to the remote controller, the drone is going to drift with the wind while maintaining its height. The maximum flight speed is 22 m/s.
Sport	S	In Sport mode, the drone is going to fly extremely fast and responsively. When there is no input to the remote controller, the drone is back to GPS mode which maintains its height and position. It is great for extreme operation required for fast and responsive flight. It also provides a fun and exciting flight experience.  As the drone becomes extremely fast and responsive in Sport mode, it is recommended to use for a more experienced and skilled user.
Orbit	O	In Orbit mode, the drone is going to proceed to a circle flight with a default 10m radius. The orbit radius can be set on the remote controller or through the App. To set the orbit radius on the remote controller, pull down the right joystick to increase the radius, pull up the right joystick to decrease the radius. The minimum radius is 10 m. The max radius can be set to 150 m.
Cruise	C	In Cruise mode, the drone is going to maintain the direction and speed of your input after you release the remote controller.
Headless	H	In Headless mode, the head orientation of the drone is dismissed. The drone can now move in the direction with respect to your point of view. This makes controlling the drone from afar more intuitive and makes manual return-to-home a lot easier when you cannot see the head direction of the drone.
Manual	M	In Manual mode, the drone is NOT going to maintain its height and position. The height, position, and speed of the drone need to be controlled manually in this mode, but the drone is going to maintain level during the flight.  This mode should ONLY be used for experienced and skilled users. Please use with caution.

<p>Boat</p>	<p>B</p>	<p>In Boat mode, the Sprinkle Drone 4 can effectively be controlled like a boat on the surface of the water. To move the drone forward, pull the right joystick up. To move the drone's direction left or right, pull the left joystick left or right to control.</p> <p>The drone is not able to move backward in boat mode. The drone's speed is limited to 1 m/s. In Boat mode, the App's mission planning can be used normally: tap to fly, route planning, grid flight planning, orbit mode.</p> <p>To enter the Boat mode:</p> <ol style="list-style-type: none"> <li>1. Land or place the drone on the water.</li> <li>2. For landing on the water, lock the drone.</li> <li>3. Switch the drone to GPS or ATTI mode.</li> <li>4. Arm the drone by using the inward gesture.</li> <li>5. Press the BOAT button on the remote controller.</li> <li>6. The drone now enters the Boat mode.</li> <li>7. Press the BOAT button again to exit Boat mode. The drone can then take off normally.</li> </ol> <p>Boat mode Application:</p> <p>For underwater photography and underwater search, use Sprinkle Pro gimbal cameras and an extension bar. For fish searching, use Sprinkle Pro fish finder Dronar 01.</p> <p>For overwater photography, use Sprinkle Pro gimbal cameras and the Gimbal Overhead Kits.</p> <p>Boat mode can ONLY be used when the drone equips with Sprinkle Pro Boat Mode Kit (BKT). DO NOT use the Boat mode without the floating foams. Using Boat mode on the water without floating foams can result in serious damages to the propellers and motors.</p> <p>When using Boat mode on the water, be careful of the landing gear and other attached accessories getting caught on</p>
-------------	----------	--



		<p>weed or other debris to prevent the drone from flying. Be aware of the weeds and other debris to prevent the landing gear and other attached accessories from getting caught by them, which can cause the drone not to be able to move or take off.</p>
--	--	--

- There is a Slow mode embedded in all flight modes for a safer flight purpose. (For example, when the drone is equipped with Sprinkle Pro Gimbal Extension Bar (GEB), switching to Slow mode allows the drone to fly more stable and safely.) Press the right PAYLOAD button 3 times to enter Slow mode.

### Intelligent Follow:

Thanks to the built-in GPS module on the remote controller. The drone can accurately track the location of the remote controller. When Follow Me mode is turned on, the drone will accurately track and follow the remote controller's position, you can still adjust the aircraft direction, following distance, camera angle on the remote controller.

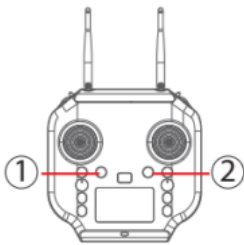

Start Follow Me: Check that the remote controller has a GPS lock by checking the GPS status indicator on the screen. Press and hold the Follow Me button (1) to start Follow Me mode. The remote controller will beep twice.

Stop Follow Me: Press and hold the "FOLLOW ME" button again until the remote controller beep once to indicate that Follow Me mode is disengaged.

- When the remote controller or the drone lost the GPS signal, Follow Me mode will automatically be disengaged, and the drone will hover on a fixed position in the air.
- When the remote controller and the drone lost connection, the remote controller will beep and vibrate once, and the drone will initiate the return-to-home process.
- ❖ Be aware of the drone's surrounding to prevent the drone from crashing into other objects when using Follow Me mode.
- ❖ Since the drone track the GPS location of the remote controller, keep the remote controller in an open-air environment to prevent the built-in GPS from signal loss. (It is not recommended to put the remote controller inside the car or kayak.)

### Smooth+:

The patented "Smooth+" flight control allows the pilot to finely tune the Roll and Yaw of Sprinkle Drone 4. Smooth+ makes professional, steady flight control as easy as turning the knobs.

- To enter Smooth+ mode, simply press the Smooth+ buttons.
- Press the left Smooth+ button to engage Smooth+ YAW. The left joystick will now only control the ascend/descend of the drone.
- Press the right Smooth+ button to engage Smooth+ ROLL. The right joystick will now only control the pitch of the drone.

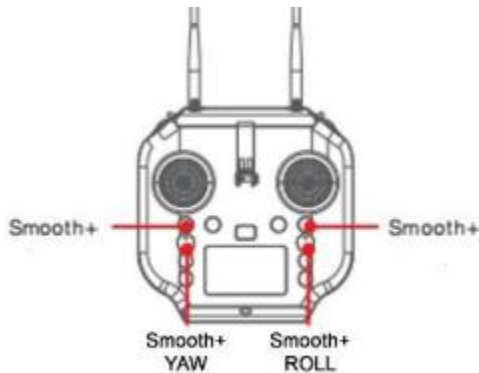

### **Dynamic Return to Home (RTH):**

The Sprinkle Drone 4 constantly senses the GPS location of the remote controller, allowing the aircraft to always return to the pilot even if they have moved from the original take-off point.

The aircraft will always return to the remote controller location, not the take-off location.

- If no GPS location is established by the remote controller, the drone would return to the take-off point.
- If the remote controller lost the GPS signal during the RTH process, the drone would return to the last known GPS location of the remote controller.

After the return function is activated either manually or automatically, the aircraft will fly to the remote controller's location. Keep in mind that when the aircraft fly back within the range of 30 meters from the remote controller, the aircraft will stop sensing the remote controller's GPS location and return to the last recorded GPS location from the remote controller. The aircraft is going to land on the remote controller's location.

### **To start Return-to-Home:**

- Long press the Return Home button, the remote controller will beep and vibrate twice to indicate that the drone starts the RTH process. The flight mode indicator on the remote controller status bar will change to the letter "R" to indicate the drone is in the RTH process.
- Return-to-Home can also be initiated on the App.
- The RTH height can be set on the App.

## Return Home Process

- If the aircraft's height is higher than Return-to-Home Height, the drone will maintain its height and return to its home point before landing.
- If the aircraft's height is lower than Return-to-Home Height and distance from Home Point > 15m, the drone will ascend to Return-to-Home Height and then return to its Home Point before landing.

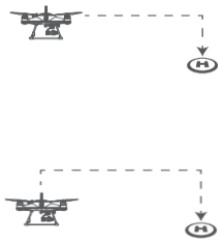

During the return home process, the left and right joysticks of the remote controller can be controlled to avoid obstacles or change the landing location. When you stop controlling the joysticks, the aircraft will continue the RTH process. During the RTH process, the Flight Mode toggle is disabled, but the control of attached accessories such as the gimbal camera or payload release module still functions normally.

Return-to-Home Height can be set on the App.

- If the aircraft's GPS signal is too weak (GPS signal shows 0), the aircraft is not able to initiate RTH.
- Keep your eyes on the aircraft during the RTH process, watch out for any obstacles on the flight path.

## Low Battery Auto Return to Home:

Low battery auto Return-to-Home can be turned on or off through the App on your preference. By default, low battery auto Return-to-Home is on.

Low battery auto Return-to-Home will be available later in 2021. Low battery auto RTH will initiate when the drone intelligent battery reaches Level 1 low battery warning.



Level 1 alarm: The drone battery level has reached 13.0 V. The remote controller screen will prompt "LOW BATTERY; Return Aircraft and Land". The front drone status indicators will flash a pattern of 4 red lights. If low battery auto Return-to-Home is turned on, the drone is going to auto RTH after this low battery warning.

## Low Battery Auto Payload Release:

Low battery auto payload release is used to increase the RTH possibility when the drone is attached to a heavy load. Low battery auto payload release can be turned on or off through the App on your preference. By default, the low battery auto payload release is off.

When it is on, the low battery auto payload release will be initiate when the drone reach level 1 low battery warning. On level 1 low battery warning, the drone will automatically release the payload then initiate low battery auto Return-to-Home process.

Low battery auto payload release will be available later in 2021.

## **6. FLY APP:**

Fly is the whole new flight App designed by Sprinkle Pro. It marks the new era for Sprinkle Pro. Fly allows Sprinkle Pro pilots to do live HD viewing; adjust aircraft and camera setting; proceed with mission planning (include route planning and grid flight planning); easily browse, download, and share aerial footage. This App currently only supports the Sprinkle Drone 4. It works both on iOS and Android.

The App does not require registration or an internet connection and can be used without uploading or sharing any personal information or data.

### **Download Fly**

For Apple devices, the iOS version is available for download on the AppStore. The Android version is available for download on the Google Play Store

### **Connect Fly**

After successfully installing the App, turn on the remote controller and then the drone. Connect your mobile device to the remote controller's Wi-Fi hotspot named SWP\_Bxxxxx. The default password is "12345678".

After connecting the Wi-Fi, open the Fly App. You can now log in to the drone.

Sprinkle Drone 4 remote controller allows for up to 10 mobile devices to connect simultaneously. Multiple people can operate the drone together. All the connected devices can control the aircraft, but only the first connected device is able to show the image transmission.

The Wi-Fi connection only supports 5G Wi-Fi (Wi-Fi 5 or Wi-Fi 6). Please use the mobile device that supports 5G Wi-Fi in order to connect to the remote controller's hotspot.

### **Use Mobile Data:**

Connecting the mobile device to the remote controller's Wi-Fi can cause the internet to be interrupted. For iOS users, proceed to the following steps to use the mobile data while connecting to the remote controller's Wi-Fi:

- Go to the device's Wi-Fi setting. Look for the remote controller's Wi-Fi (SWP\_Bxxxxx). Tap in the setting for the Wi-Fi.
- Under IPV4 address, set "Configure IP" from automatic to manual mode.
- Configure the manual IP: IP address to "192.168.2.110"; Subnet Mask to "255.255.255.0".
- Your iOS device is now able to use mobile data while connecting the remote controller's Wi-Fi.

Note: this method only works for iOS devices. Android devices will be supported at the end of 2021.

### Map Download:

Since the mobile device uses Wi-Fi to connect to the remote controller, for Apple users, it is totally fine, proceed to the steps to use mobile data in conjunction with the Wi-Fi connection. However, for Android users, it may result in no internet service, which leads to the map malfunction. Simply go to the Wi-Fi setting and turn on the smart connection to allow the phone to use the mobile network while connecting to the Wi-Fi. If your mobile device does not support the smart connection, you can also choose to download the map for the use of the intelligent flight mission.

To download the map:

1. Login to the device.
2. Go to the map interface.
3. Tap the map download icon [1] as shown.
4. Area adjustment [9] is going to show up. Set the desired size of the map you want to download.
5. Then tap the location on the map [10] you want to download.

Map download is also great for flying in remote areas where mobile signal is weak.



### Main Interface:

- [1] Main interface
- [2] Browse/Share pictures videos
- [3] Info
- [4] Login to the drone

## [5] Connection Status

### **Camera Interface:**

1. Home Screen: Return to the main interface.
2. Flight Status: Displays the flight status of the aircraft and warning information.
3. Camera Parameters: Current camera parameters.
4. Memory card Information: Remain memory card capacity.
5. Flight Mode: Current flight mode.
6. GPS Signal Level: GPS signal quality.
7. Remote Controller Signal Level: The signal quality between the remote controller and the aircraft.
8. Aircraft Battery Level: Real-time display of the battery voltage.
9. Flight Settings: Set the drone flight settings and configure flight parameters.
10. Camera Settings: Set camera parameters and settings.
11. Photo: Take a photo.
12. Video: Start/stop video recording.
13. Playback: Browse photos and videos that have been taken.
14. Flight Parameters: D: Distance between the aircraft and the home point | H: Aircraft height from Home Point | HS: Aircraft horizontal speed | VS: Aircraft vertical speed
15. Thumbnail map: Tap to quickly switch to the map interface.
16. Mission terminate: Tap to terminate current flight planning. (Tap to Flight, Route Planning, Grid Flight Planning)
17. Tap to return: Tap to start automatically return to home (RTH) and land 3 meters in front of Remote controller current position and turn off the motors.
18. Tap to take off: Tap to automatically take off and hover at a height of 3 meters.

### **Set the Wi-Fi Password:**

To set the Wi-Fi password:

1. Connect the Fly to the remote controller.
2. Login to the device.
3. Go to flight settings, showing as 3 dots on the top right of the interface.
4. Scroll to advanced settings and select "Set Wi-Fi Password".
5. Type the password you want and press "SAVE PASSWORD".
6. Re-connect the Wi-Fi.

### **Reset the Wi-Fi Password:**

To reset the Wi-Fi password:

1. Power on the remote controller.
2. Wait for 40 seconds for the MultiSync video transmission system to boot up.
3. Press the pairing button on the back of the remote controller 5 times.
4. Wait for another 20 seconds for the Wi-Fi password reset to finish. The Wi-Fi password is restored to the default, 12345678.

After resetting the Wi-Fi password, re-pairing the remote controller and the aircraft is **REQUIRED**. To re-pair, the remote controller, and the aircraft, check the pairing part under the remote controller section.

## 7. APPENDIX:

<b>SD Specification</b>	<b>&amp;</b>	<b>Accessories</b>
<b>Aircraft</b>		
Waterproof Rating:	IP67	
Weight (include battery and propellers) :	2.18 kg	
Axis Diameter:	450 mm	
Max Ascend Speed:	4 m/s	

Max Descend Speed:	4 m/s
Max Flight Speed:	22 m/s ( ATTI), 10 m/s ( GPS)
Max Tilt Angle:	ATTI: 12.5°; ATTI (fast): 25°
Max Altitude from Takeoff Point:	120m (GPS) / ATTI - no limitation
Max Wind Speed Resistance:	72 km/h   20 m/s   39 knot
Max Flight Time:	30 mins (no wind & no load); (approx. 25 mins with GC3-S, approx.15 mins with load of 1.5kg)
Hovering Precision:	±0.5 m (vertical); ±0.5 m (horizontal)
Max Flight Distance:	5.0 km
Max Payload Capacity:	2.0 kg
Flight Control:	Hawk
Digital Video Transmission:	MultiSync
Motor:	#3509 - 740Kv (special coated)
ESC:	40A (flux)
Propellers:	#1242 carbon fiber quick release propellers
Motors:	#3509 - 740Kv
Operating Frequency:	5180 - 5875 MHz
Transmitter Power (EIRP):	FCC/IC: ≤ 24 dBm CE/SRRC/MIC: ≤ 20 dBm
Working Temperature:	-10°C ~ 40°C
Satellite Positioning Systems:	GPS/GLONASS
Pass-through Serial Port:	Connect to a third-party device and transfer the data of the third-party device to the remote control
UART:	Allows for TTL serial port to TCP, with baud rate of 115200
Wi-Fi Hotspot	IP: 192.168.1.101:2222
Power Input:	12V/2A   5V/2A

### Remote Controller (MRC)

Waterproof Rating:	IP66
Operating Frequency:	5180 - 5875 MHz
Transmitter Power (EIRP)	FCC/IC: ≤ 24 dBm CE/SRRC/MIC: ≤ 20 dBm
Real-time Video Transmission :	720P@30fps



Latency:	200 ms (It depends on the actual shooting environment and mobile devices)
Battery:	2S 3600mAh
Working Time:	7 hours
Working Current/Voltage:	0.3A/7.4V
Ethernet Port:	IP: 192.168.2.220:2222
Wi-Fi Hotspot	IP: 192.168.2.220: 2020; Default password: 12345678
Mobile Device Mount:	Suitable for any size phones; Tablets require an larger mount(sold separately)
Screen:	2.68 inch, 128x64
Working Temperature:	-10°C - 40°C
Remote Charging time:	3 hours
Power Input:	5V/2A

#### **Intelligent Battery (IB4)**

Nominal Capacity:	6600mAh
Voltage:	14.8V
Type:	Intelligent 4S LiPo
Watt Hours:	97.68 Wh
Size:	153.6*82.4*48.3mm
Weight:	735 g (±5 g)
Working Temperature:	-10°C - 40°C
Charging Time:	1.5 hour
Max Charging Power:	84 W

#### **Charger**

Input	100 – 240V, 50/60Hz
Output:	16.8V@Dynamic Current / 5V@1.5A
Rated Power:	84.5 W

#### **Mobile Device connection**

Operation Frequency	5180 - 5875 MHz
Max Transmission Distance (Unobstructed, free of interference)	10 m

<b>APP</b>	
Mobile App Name	FLY
Live View Quality	720p@30fps
Latency	< 250 ms (depending on environmental conditions and mobile devices)

### **1-Axis Gimbal Camera (GC1-S)**

Waterproof:	IP67
Axis:	1-axis (tilt)
Controllable range:	tilt: -90° to 0°
Max control speed:	tilt: 60°/s
Weight:	Approx. 145g
Size:	71*55*65mm

Sensor:	1/2.3" 12M SONY CMOS
Lens:	F4.53mm f/2.65, FOV: 92.6°
ISO Range:	100 - 3200
Shutter Speed	16 - 1/16000 s
Photo Resolution:	4:3/16:9 12MP
Burst Mode:	3/5/10 pcs
Video Resolution:	4K: 3840*2160/30P   2.7K: 2704*1520/60P   FHD: 1920*1080 30/60/120P   HD: 1280*720/240P
Max Video Bitrate:	64 Mbps
Photo Format:	JPEG / DNG (RAW)
Video Format:	MP4 / MOV
Memory Card:	Micro SD card: supports up to 128GB of capacity, write speeds ≥ 60 MB/s, recommend using Class 10 or above, or with UHS-1 rating.
Working Temperature:	-10°C to 40°C

### **2-Axis Night Vision Gimbal Camera (GC2-S)**

Waterproof:	IP67
Axis:	2-axis (tilt, roll)
Controllable range:	tilt: -90° to 0°
Max control speed:	tilt: 60 °/s

Weight:	Approx.220g
Size:	113*92*80mm
Sensor:	1/2" 2M Starlight CMOS
Lens:	FOV: 66°
Burst Mode:	3/5/10 pcs
Video Resolution:	FHD: 1920*1080 30/60P   HD: 1280*720 120/60P
Max Video Bitrate:	64 Mbps
Photo Format:	JPEG
Video Format:	MP4 / MOV
Memory Card:	Micro SD card: supports up to 128GB of capacity, write speeds ≥ 40 MB/s, recommend using Class 10 or above, or with UHS-1 rating.
Working temperature:	-10°C to 40°C
<b>3-Axis Gimbal Camera (GC3-S)</b>	
Waterproof:	IP67
Axis:	3-axis (tilt, pan, roll)
Controllable range:	tilt: -90°to 0°
Max Control Speed:	tilt: 60°/s
Weight:	Approx. 310g
Size:	113*92*110mm
Sensor:	1/2.3" 12M SONY CMOS
Lens:	F4.53mm f/2.65, FOV: 92.6°
ISO range:	100 - 3200
Shutter Speed	16 - 1/16000 s
Photo Resolution:	4:3/16:9 12MP
Burst Photo:	3/5/10 pcs
Video Resolution:	4K: 3840*2160/30P   2.7K: 2704*1520/60P   FHD: 1920*1080 30/60/120p   HD: 1280*720/240p
Max Video Bitrate:	64 mbps
Photo Format:	JPEG / DNG (RAW)
Video Format:	MP4, MOV

Memory Card:	Micro-SD card with a maximum capacity of 128GB, write speed $\geq$ 60 MB/s, recommend using Class 10 or above & UHS-1 rating
Working temperature:	-10°C to 40°C

### 3-Axis Thermal Gimbal Camera (GC3-T)

Waterproof:	IP67
Axis:	3 axis (tilt, pan, roll)
Controllable range:	tilt: -90° to 0°
Maxcontrol speed:	tilt: 60°/s
Weight:	Approx. 450g
Size:	110*100*115mm

### Low-light Camera

Image Sensor:	1/2" 2M Starlight CMOS
Lens:	FOV: 66°
Burst Photo:	3/5/10pcs
Video Resolution:	FHD: 1920*1080 30/60p   HD: 1280*720 120/60p
Max Video Stream:	64 Mbps
Photo Format:	JPEG
Video Format:	MP4 / MOV
Support Memory Card:	Micro SD card: supports up to 128GB of capacity, write speeds $\geq$ 60 MB/s, recommend using Class 10 or above, or with UHS-1 rating.
Working temperature:	-10°C to 40°C

### IR Camera

Image Sensor:	Vanadium oxide uncooled infrared focal plane detector
Lens:	19mm/25mm
Resolution@frame rate:	640*512 @30p/48p/50p
Palette:	White hot / black hot / Rainbow / Rainbow high contrast / iron red / lava / Sky / medium gray / grey red / purple orange / Special 1 / warning red / ice fire / cyan red / special 2 / gradient red / gradient green / gradient blue / warning green / warning blue
Crosshairs :	Show (default), hide, move
Contrast Ratio :	Slider adjustment (0-255)
Brightness:	Slider adjustment (0-511)
DDE gear (image enhancement):	Off / On (default on)

Temperature measurement OSD on / off:	Off / On (the default displays the highest, lowest, and center point temperatures)
Temperature measurement unit :	Centigrade, Kelvin, Fahrenheit
Temperature measurement alarm :	Off, low temperature alarm, high temperature alarm, high and low temperature alarm
Low temperature alarm setting:	-20°C~+150°C
High temperature alarm setting:	-20°C~+150°C

### Fixed Angle Camera (FAC)

Waterproof Rating:	IP67
Weight:	Approx. 85g
Size:	45*44*40mm
Image Sensor:	1/2.7" 2M SONY CMOS
Lens:	F2.2mm f/5.06, FOV: 130°
Burst Photo:	3/5/10 pcs
Video Resolution:	FHD: 1920*1080 30/60p, HD: 1280*720 120/60p
Max Video Stream:	30 Mbps
Photo Format:	JPEG
Video Format:	MP4 / MOV
Memory Card:	Micro SD CARDS with a maximum capacity of 128GB, write speed ≥ 30 MB/s, recommend using Class 10 or above & UHS-1 rating
Working temperature:	-10°C to 40°C

### Payload Release (PL1-S)

Waterproof Rating:	IP67
Weight:	59*38*50mm
Size:	96 g
Max loading weight:	2 kg

### Parachute (PTE4)

Size:	155*134*122mm
Weight:	500 g
Max. loading weight:	6 kg

Release:	Manual/Automatically
----------	----------------------

### Life Buoy (LB1)

Weight:	366 g
Size:	205*100*65 mm
Material:	Polyester Oxford neoprene
Airbag material:	Nylon+ TPU
Inflation Time:	less than 5s
Buoyancy:	73 N
Buoyancy time:	more than 48 hrs
Loss of buoyancy after 24 hours :	≤5%
Carbon dioxide weight:	3 / 8-24UNF, 24g

### Extension Bar

Weight:	138 g
Length:	40 cm
Material:	Carbon fiber tube & alluminum base

### Dronar 01 (Fish Finder)

Depth Range Max:	120 feet (40 m)
Depth Range Min:	2 feet (0.6 m)
Sonar Frequency:	125 kHz Single Beam
Cone Angle:	30°
Audible Alarms:	Fish, Depth, Low Battery
Working Temperture:	-20°C to 80°C
Transmission Distance:	10 m with phone; 3km with drone
Interface:	Dronar APP
Battery:	3600 mAh, 11.1 V; 39.96 Wh
Connection:	5Ghz Wi-Fi

### Water Sampling Kit

Weight:	56 g
Bottle Cap Finish:	30-400/410/415 Diameter: 30 mm Height: 9 mm

Bottle Size:	for standard 350 ml & 550 ml plastic water bottle
Material:	aluminum

## Metorage microSD Card

### Firmware Update:

For the best flight experience, please update the aircraft and the remote controller to the latest firmware.

### Flying Guide

- Many regulations require the pilot to fly a drone within line of sight. Take particular care when flying a drone out of sight.
- Unless it is an emergency, NEVER Lock or STOP the motors in flight as this will cause the drone to fall to the ground and crash.
- When the low battery level warning is activated, plan to return the drone and land safely before the battery reaches a critical level.
- The Return Home function can be used to reorient the drone towards the Home Point. By activating the Return Home function, the drone will rise to the return altitude (20m) and then turn towards the Home Point before starting its return.
- If any obstacles are in the flight path of the drone during a Return Home process, control should be regained by turning off the Return Home function.
- If you crash your drone, lock the motors to prevent damage to the motors and propellers.
- Do not attempt to touch the motors, until the motors have stopped rotating completely.
- When landing on water, avoid abrupt landings to avoid damage to the drone.
- When flying over water, avoid the drone dropping or crash into the water from a high altitude as this could cause major damage to the drone.
- Do not expose the drone & battery to direct sunlight for long periods as this can raise the internal temperature of the drone to well above the operating temperature range.
- If the drone does not Appear to be responding to the remote controller, as usual, switch the drone to ATTI flight mode and fly the drone to a safe landing location.
- The possible causes for the instability or loss of control of the drone could be poor GPS signal, poor radio signal, or weak Earth magnetic field.
- If the drone Appears to be affected by magnetic interference, try the following remedies.
- Re-calibrate both the compass and accelerometer on the Sprinkle Drone 4.
- After completing the calibration, arm the drone motors to fly in GPS mode to verify whether this phenomenon has been eliminated.
- If the abnormality remains the same, please re-locate to another place at least 5KM away and re-calibrate the Sprinkle Drone 4. Following the re-calibration, please test the drone again.

- If the problem persists, please contact Sprinkle Pro or your local dealer for further troubleshooting and solutions.

### **Joystick Calibration:**

Calibration of the joysticks is necessary if the third page of the remote controller screen indicates that the control inputs are not centered when the joysticks are in their neutral position.

To calibrate the joysticks, refer to the Sprinkle ProTools firmware update instructions.

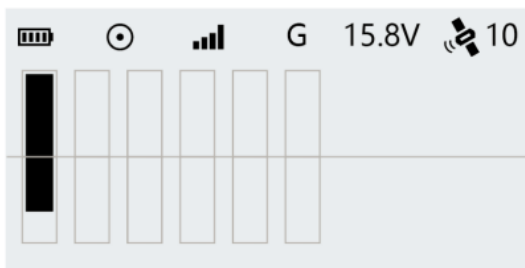

- ⚠ It is necessary to calibrate the remote stick when changing the throttle mode.
- ⚠ Before calibration, make sure that all toggle switches are set to the top position.

### **Battery Care and Maintenance**

- Do not allow the batteries to come into contact with any kind of liquid.
- Do not drop the battery into the water.
- Do not leave batteries out in the rain, or near a source of moisture. If the inside of the battery comes into contact with water, chemical decomposition may occur, potentially resulting in the battery catching on fire, and may even lead to an explosion.
- Never use or charge swollen, leaky, or damaged batteries. If your batteries are abnormal, please contact Sprinkle Pro or a Sprinkle Pro authorized dealer for further assistance.
- The battery can be used in temperatures ranging from -10°C to 40°C. Using the battery in environments above 60°C can lead to a fire or explosion. Using the battery below -10°C can lead to permanent damage.



- Never disassemble, or penetrate the batteries with sharp objects, otherwise, this may result in the battery catching fire, or even lead to an explosion.
- Electrolytes in the battery are highly corrosive. If any electrolytes make contact with your skin or eyes, immediately wash the affected area with fresh running water for at least 15 minutes, and then see a doctor immediately.
- If the battery falls into water, pick it up immediately and put it in a safe and open area. Maintain a safe distance from the battery until it is completely dry. Never use the battery again, and dispose of the battery properly as described in the Battery Disposal section below.
- Do not heat batteries. A battery fire can be extinguished using sand, or a dry powder fire extinguisher.
- Do not put batteries in a microwave oven, or a pressurized container.
- Do not put the loose battery cells onto any conductive surface, such as a metal table.
- Do not put any conductive cables or metal objects together with batteries, where they may short-circuit against each other.
- Do not drop or strike batteries.
- Do not place heavy objects on the batteries or the battery charger.
- Clean battery terminals with a clean, dry cloth. Failure to do so may result in poor electrical contact, which could reduce the battery capacity, or damage the charger.
- Do not continue to fly the drone after the low battery alarm has been activated; this will result in over-discharging the battery, and potentially could damage the battery cells.

#### **Precautions for low-temperature use:**

- When the battery use in a low-temperature environment (-10°C to 5°C), the battery capacity and flight time will be drastically reduced. It is recommended to take off when the battery is fully charged. Please fully charge and keep the battery warm before use.
- In a low-temperature environment, it is recommended to preheat the battery to above 5°C before flying, and it is better to preheat to above 20°C.
- Before flying in a cold environment, insert the battery into the aircraft to warm up for 1 to 2 minutes, and take off after the battery is fully warmed up.

#### **Battery Charging**

- Always use a Sprinkle Pro Approved charger to charge the battery of the drone, and the radio controller. Sprinkle Pro takes no responsibility if the battery is charged using a non-Sprinkle Pro charger.
- To avoid any potential accidents happening, please do not leave the battery charging unattended.
- Do not charge the battery near flammable materials, or on flammable surfaces, such as carpet or wood.

- Disconnect the charger when not in use.
- Do not clean the charger with denatured alcohol or other flammable solvents.
- Never use a damaged charger.

### **Battery Storage and Transportation**

- Keep batteries out of the reach of children and pets.
- Do not leave the battery near heat sources, such as a furnace, heater, or exposure to strong direct sunshine, for example: in cars
- The ideal storage temperature is 20°C ~ 28°C.
- Keep the battery in a dry and ventilated environment
- Never drop the battery into the water, or store it in places where there is a possibility of water leakage.
- Do not drop, strike, impale, pierce, or manually short-circuit the battery.
- Keep the battery away from metal objects, such as watches, jewelry, and hairpins.
- It is recommended to recharge the battery once every 2 months when the battery is in storage.
- It is recommended to fully charge the battery before put into storage, as the higher the battery level, the longer the battery can be stored.

### **Battery Disposal**

- Dispose of the battery in specific recycling boxes only after a complete discharge.
- DO NOT place the battery in regular trash containers. Strictly follow your local regulations regarding the disposal and recycling of batteries.

### **Maintenance:**

- After flying over the sea, sand, or water, the Sprinkle Drone 4 and modules must be thoroughly washed with freshwater within 2 hours and dried - especially the motors, gimbals, and camera.
- It is strongly advised to rinse the drone before any salt crystallizes.
- Motors are best rinsed by removing the propellers and immersing the motors one at a time into a bucket of warm fresh water and arming the drone in ATTI flight mode so the motors spin underwater.
- In the event of the Sprinkle Drone 4 not being used for a long time, please store the drone and the batteries in a dry, and ventilated environment at 20°C~28°C. Refer to the Maintenance manual for more maintenance information.

## **Disclaimer and Warning:**

This product is not a toy and should only be operated by persons over the age of 18. Please keep it out of reach of children and pay particular attention to the possible scenarios of children unexpectedly Appearing during flight operations.

Be sure to read this document carefully before using the product, to fully understand your legal rights, responsibilities, and safety instructions. Failure to do so may cause property damage, accidents, and personal injury. Once this product is used, it is deemed that you have understood, recognized, and have accepted all the terms and conditions of this statement.

The user is responsible for all the consequences of his actions and the use of the product. The user agrees to use the product for his sole & legal purpose and agrees with the terms & conditions of this agreement, and other relevant policies & guidelines that may be specified by Sprinkle Pro.

Under the maximum permitted by law and Approved circumstances, Sprinkle Pro accepts no liability for any indirect, punitive, consequential, special, or criminal damages, including the purchase cost, or loss of income due to the loss of use of the drone.

Sprinkle Pro is exempt from the user's liabilities for damage(s) to person/s or property, or injuries incurred directly or indirectly from the use of this product in the following conditions:

- Damage or injuries incurred when the user/s are under the influence of alcohol, drugs, or medication.
- Any malfunction caused by operators' failure to follow the guidance of the manual to assemble and set up or operate the drone as described and designed.
- Damage or injuries may occur due to failure to study the tutorial videos and the user manual before flying the drone.
- Damage or injuries caused to a person/s or property due to failure in correctly calibrating the drone as outlined in the manual before the flight.
- Damage or injuries incurred as a result of the use or installation of any unauthorized third-party accessories or counterfeit parts - which were not provided and Approved of by Sprinkle Pro.
- Damage or injuries as a result of flying the drone out of eyesight range, or more than 300m away from the controller.
- Damage or injuries caused by flying the drone in areas of magnetic fields & radio interference. • Damage or injuries caused by flying in a NO-FLY ZONE that is regulated by local laws & rules.
- Damage or injuries including crashes, loss of control, or water ingress caused by abusing or modifying the original drone structure,
- Damage or injuries caused by using broken & aging components.
- Damage or injuries caused by continuing to fly the drone even if the low battery alarm is activated.
- Damage or injuries caused by failure to wash the components with fresh water after flying over or near the sea & corrosive waters.

- Damage or injuries that have occurred when the drone has been subjected to the following conditions or situations: collision, fire, explosion, floods, tsunamis, ice, snow, avalanche, flooding, landslide, earthquake, etc.
- Damage or injuries incurred by intentionally dropping or crashing the Sprinkle Drone into the water from a high altitude, especially water ingress into the drone fuselage and gimbal malfunction.
- Damage or injuries incurred by intentionally dropping or crashing the Sprinkle Drone to the ground or water from a high altitude, especially water leakage into the drone fuselage and gimbal frame as a result of this collision.
- Other Damage(s) or injuries that are not Sprinkle Pro's liability.