



Product Name	GAOTek Glucometer Healthcare
Product SKU	GAOTek-SI-109
Product URL	https://gaotek.com/product/gaotek-glucometer-healthcare/

Contact us: sales@gaotek.com

Based in New York City & Toronto, GAO Tek Inc. is ranked as one of the top 10 global B2B technology suppliers. GAO ships overnight within the U.S. & Canada & provides top-notch support thanks to its 4 decades of experience.



Contents

1.	About the Meter	3
2.	Blood glucose meter and LCD window.....	4
3.	Glucose Test Strip	7
4.	Setting Meter Parameters	8
5.	Preparing for Blood Sampling Adjustable Lancing Device.....	9
6.	Checking the Code	10
7.	Performing a test with blood glucose test strip	11
8.	Understanding your test result	13
9.	Memory recall.....	13
10.	Control solution (optional).....	14
11.	Meter specifications	15
12.	Taking care of your meter	16
13.	Disposing your meter	18
14.	Displaying messages and troubleshooting	19



GAOTek Glucometer Healthcare

1. About the Meter

Intended Use

The blood glucose meter is designed to quantitatively measure the concentration of glucose in capillary whole blood by people with diabetes or by healthcare professionals for monitoring blood glucose at home or in healthcare facilities. The device is an over-the-counter device indicated for professional use and for home use. The meter is for quantitative blood glucose testing with blood glucose test strips.

About the Meter

The blood glucose meter uses the biosensor technology in blood glucose monitoring to provide you with easy and comfortable testing. It requires only 0.8 μ L blood sample to complete the testing in just 8 seconds.

Important Information

The blood glucose meter is intended for in vitro diagnostic use with capillary whole blood. The meter should not be used for diagnosis of diabetes or for testing newborn infant (neonatal testing).

Caution

1. The user should not take any decision of medical relevance without first consulting with his or her medical professionals.
2. Call your doctor immediately if you experience symptoms that are not consistent with your blood glucose test results.
3. Severe dehydration or excessive water loss may cause false results. Call your doctor right away if you believe you are suffering from dehydration.
4. A red blood cell count (hematocrit) that is either very high (over 65%) or very low (under 25%) may cause false result.
5. High altitudes may affect the test results.
6. Operating temperatures outside the range of 10°C to 40°C (50°F to 104°F) may affect the test results.
7. Interferences: Acetaminophen, Dopamine, L-DOPA, Ibuprofen, Salicylate, Bilirubin, Creatinine, Cholesterol, Triglycerides, Uric acid, EDTA, Galactose, Gentic acid, Glutathione, Haemoglobin, Heparin, Maltose, Methyl-DOPA, Tolbutamide, Tolazamide,

Xylose, Pralidoxime Iodide and Icodextrin (when occurring in normal or therapeutic concentrations) do not significantly affect results. However, abnormal high concentrations

of substances, such as Acetaminophen, Salicylate, Uric acid, and other reducing substances in blood, may cause inaccurate high results.

- Intravenous administration of ascorbic acid which results in blood concentration of ascorbic acid >3 mg/dL will cause overestimation of blood glucose results.

2. Blood glucose meter and LCD window



- DISPLAY:** The large, easy to read display shows blood glucose results, messages, glucose results stored in memory, time and date.
- “M” BUTTON:** Press to enter memory mode to recall the information stored in meter’s memory and to increase values in setting mode.
- “S” BUTTON:** Press to enter time setting, and to decrease values in the setting mode.





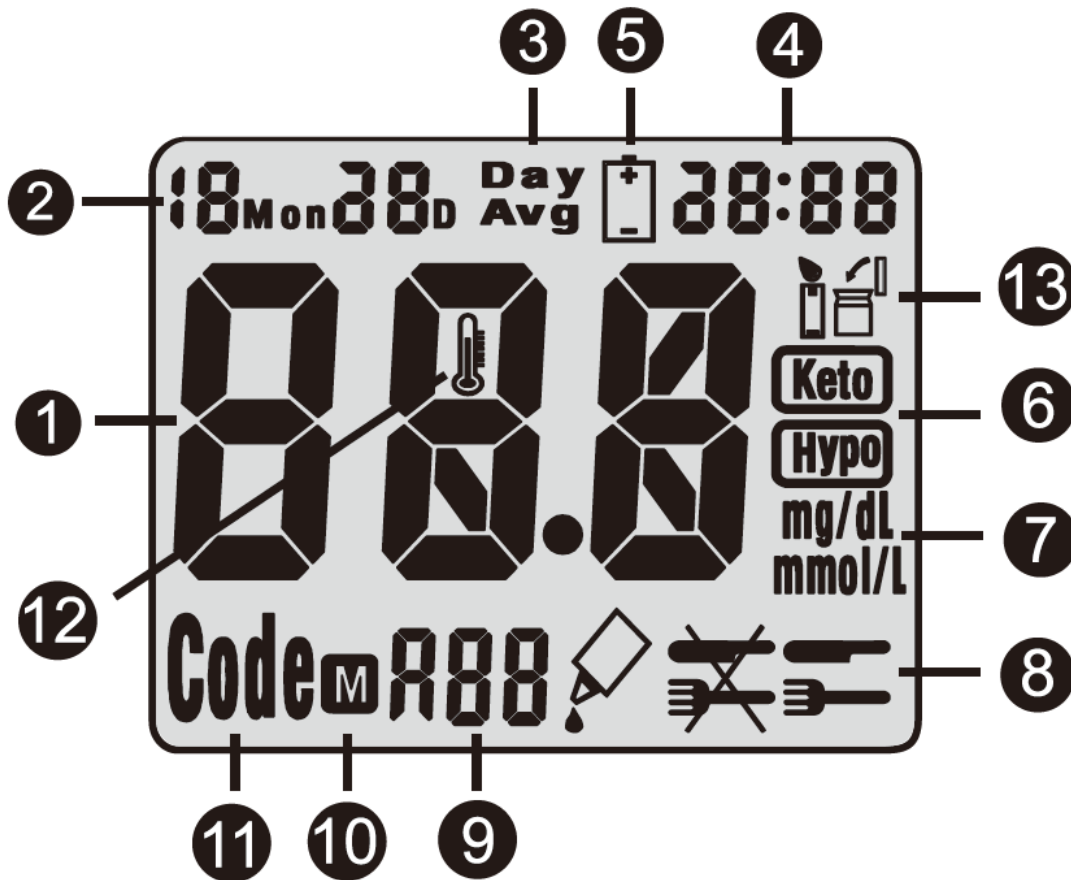

- 4. **STRIP SLOT:** Holds a test strip or check strip in place when you perform blood glucose test or perform check tests.
- 5. **DATA PORT:** Allows you to transfer the information stored in the meter's memory to a computer to view, analyze and print.
- 6. **BATTERY COMPARTMENT:** Holds one 3V lithium battery. The battery is not installed into meter when newly purchased. Please install the battery first before use.
- 7. **METER LABEL:** Label of the meter.





TEST RESULT

1. **DATE:** Month/date.
2. **DAY AVG:** Appears when the meter is in the memory mode while recalling 7/14/21/28-day test averages.
3. **TIME:** 24-hour period format.
4. **BATTERY SYMBOL:** Appears when battery is low.
5.  **SYMBOL:** “Keto” symbol appears when the blood glucose concentration is above 17.8mmol/L (320 mg/dL). This simply suggests that a ketone test is recommended. Consult your healthcare professional about testing for ketones; “Hypo” symbol appears when the blood glucose concentration is below 3.9 mmol/L (70mg/dL).
6. **Mg/dL/mmol/L:** Results are displayed as mg/dL or mmol/L.
7.  **SYMBOL:** The test can be adjusted and stored into 3 types of test modes - BEFORE MEAL TEST (AC), AFTER MEAL TEST (PC), and CONTROL SOLUTION TEST (QC).
8.  : This display shows to indicate that all digits are working properly.
9.  : appears when reading previous results.
10. **CODE:** Code appears to indicate code number when it's ready to test.
11. **THERMOMETER SYMBOL:** Appears when ambient temperature is outside the acceptable range needed for testing.

12. STRIP SYMBOL: Appears when the test strip is inserted, and meter is ready for blood testing. Recap the vial immediately after removing test strips.

3. Glucose Test Strip

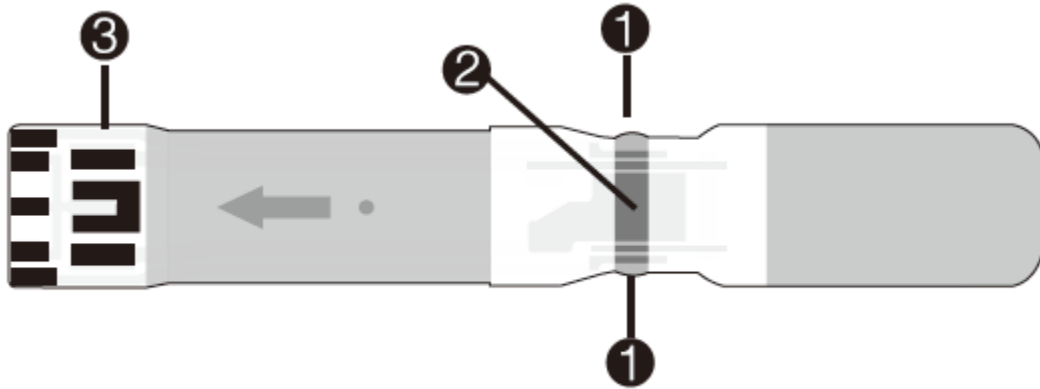

1. Sampling Port: apply the blood to either side of strip.
2. Detection Zone: make sure the part is filled up with blood to ensure the correct results.

For example:

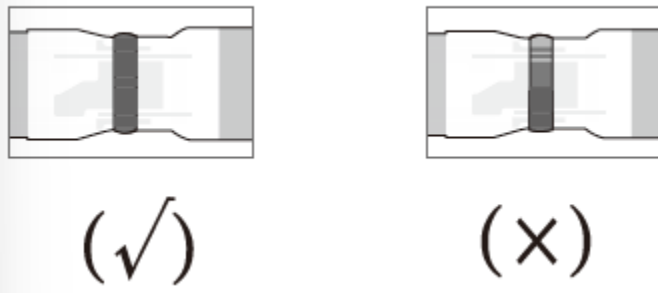

3. Electrode End: insert the end of test strip into meter.

IMPORTANT INFORMATION:

1. Do not use damaged test strips or test strips changed in any way. Use test strip immediately after removing it from the vial. Recap the vial immediately and close it tightly.

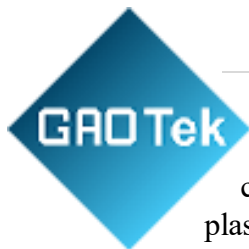

2. Blood Glucose Test Strips are intended for in vitro diagnostic use with capillary whole blood or control solution. Results will not be accurate if used with plasma or serum samples.
3. Blood Glucose Test Strip can be damaged by heat and light. Keep them sealed in the original vial. Keep the vial in a cool, dry place below to 30°C/86°F and above 5°C/41°F.
4. Do not refrigerate.
5. Do not use test strips beyond the expiration date indicated on the vial. The discard date for test strips is three (3) months after first opening the vial. Record the discard date on the vial, when you open a new one.
6. For single use only.
7. Do not carry loose test strips in your carrying case.

4. Setting Meter Parameters

Setting Date, Time

When the battery is installed the first time or every time it's replaced, the meter will automatically enter the setting mode. Please set the current time and date before you begin testing.

To set the time and date

1. Press "S" button for 2 seconds to turn on the meter. The meter will enter to the setting mode automatically.
2. The year flashes at the sound of beep, for example for the year of 2017, number "17" will flash.
3. Press "S" button to obtain the desired year.
4. Press "M" button to confirm and shifts to the next setting.
5. Repeat to set the month, date, hour and minute.
6. After minute is set, the meter will display "OK" before turning off.

5. Preparing for Blood Sampling Adjustable Lancing Device

Used with **lancet** to obtain a blood sample.

1. Depth adjustment Cap
2. Depth Selector
3. Lancet Holder
4. Cocking Control
5. Release Button
6. Exit Button

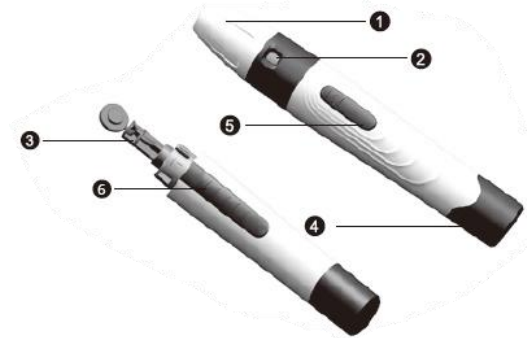

Lancet

Used with lancing device to obtain a blood sample.

1. Protective cap



Important Information

- Lancet is for single use only.
- Keep lancing device and lancets clean.
- Use caution when removing the used lancet from the device and disposing.
- The lancing device and lancets are in conformity with MDD 93/42/EEC. Refer to product labels for contact information of manufacturer and CE marking.

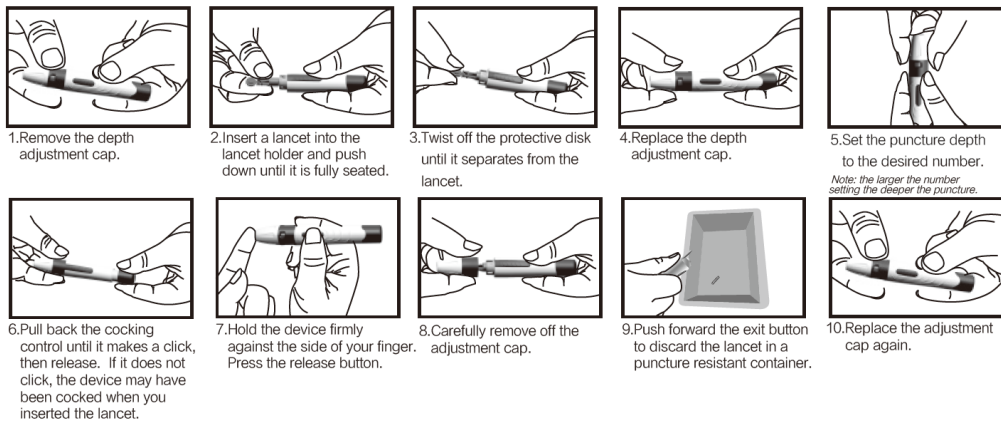

6. Checking the Code

Before you perform your first blood glucose test or every time you open a new box of test strips, you need to verify that the meter “matches” the strips.

1. Insert the test strip into the meter in the direction of the arrows. The meter turns on and beeps. The code number appears briefly.
2. Make sure the code number on the display matches the code number on the test strip container.

If the two numbers do not match, please contact us or your local distributor. If you miss seeing the code number, remove the test strip and reinsert it into the meter. If the two numbers match you may begin blood testing.

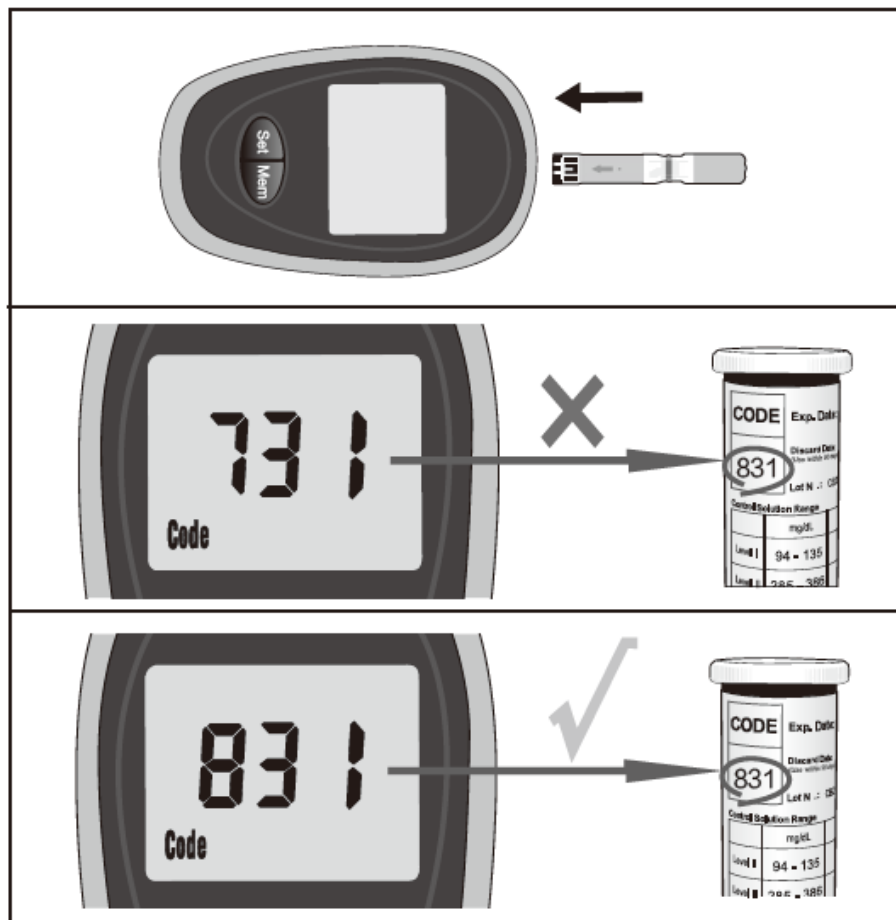

7. Performing a test with blood glucose test strip

1. Wash your hands in warm, soapy water (FIG 1). Rinse and dry completely. Warm your fingers to increase blood flow.

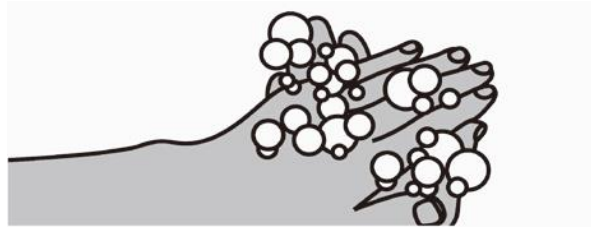

2. Remove a new test strip from vial. Be sure to tightly re-cap the vial after removing test strips. Insert test strip immediately into strip slot as illustrated (FIG 2). The meter turns on automatically.

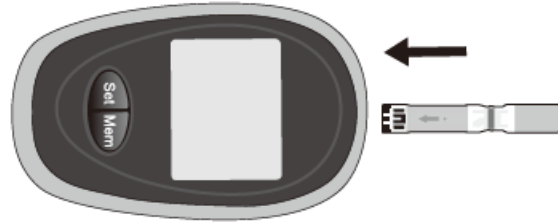

3. Check the code number in the meter matches the code on the vial of test strips you are using (FIG 3).



4. When the symbol flashes, you are ready to perform a test (FIG 4).



5. Use the lancet loaded in lancing device to obtain a drop of blood on the side of your finger. Hold the device firmly against the side of your finger. Press the release button (FIG 5). Gently massage your finger to obtain the required blood volume. To perform the test, you need only 0.8µL of blood sample.

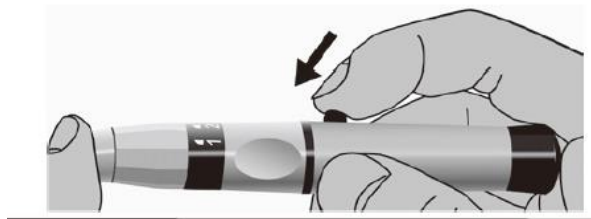

6. Apply the blood sample to the right or left edge of the test strip in a way that is comfortable to you (FIG 6). Make sure that the blood drop has saturated the test confirmation window. When blood is applied to the strip, a line moves on the display until measurement is completed.

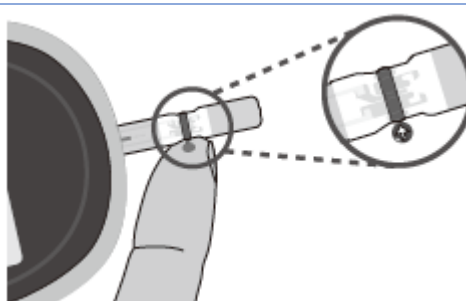

7. Your result will show up in 8 seconds, and it is automatically recorded in the meter's memory. You may also want to record the result in your logbook.

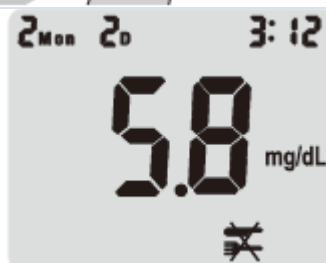

8. If the test is being done within 2 hours after meal, press "S" button to change the setting from AC to PC. If the test is a control solution test, press "S" button again to change the setting from PC to QC (FIG 7).

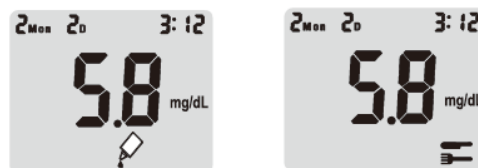

NOTE: IF A TEST IS SET AS "QC", THE RESULT WILL NOT BE CALCULATED INTO AVERAGES.

9. After testing completed, remove the test strip from the meter (FIG 8). Discard the strip and lancet safely in a puncture resistant container.



10. The meter has risk indicator function. If "LO" is displayed, your blood glucose result may be higher than 320 mg/dL (17.7mmol/L). If "HI" is displayed, your blood glucose result may be lower than 70 mg/dL (3.9mmol/L). The testing range of the meter is from 20 to 600 mg/dL(1.1-33.3mmol/L). If "HI" is displayed, your blood glucose result may be higher than 33.3 mmol/L or 600 mg/dL. If "LO" is displayed, your blood glucose result may be lower than 1.1 mmol/L or 20 mg/dL (FIG 9).

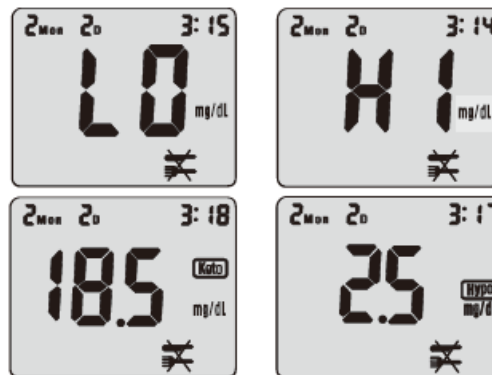



8. Understanding your test result

- The normal blood glucose range is 70 to 100 mg/dL (3.9 to 5.6 mmol/L) for fasting and less than 140 mg/dL (7.8 mmol/L) two hours after meals for a non-diabetic adult. Consult your healthcare professionals to find out your target blood glucose value.
- If your blood glucose result seems unusually high or low, or inconsistent with your previous results, check the followings:
 1. Does the code number on the test strip vial match the code number on the meter?
 2. Was the blood sample applied to the test strip immediately after removing it from the vial?
 3. Was the size of the blood sample sufficient?
 4. Was the test strip vial cap tightly sealed?
 5. Were the test strips expired?
 6. Were the test strips stored away from extreme temperatures in very cold or hot weather or from areas of high humidity?

9. Memory recall

Blood Glucose Meter can automatically store up to 180 test results and automatically calculate your average results of 7-, 14-, 21-, 28-days on both AC and PC. When recalling the results, each single result appears from the latest to the earliest with corresponding time and date.

To Recall Results Stored in Memory

1. Turn meter on by pressing “M” button until you hear a beep sound. The first result displayed on the screen is your latest test result.
2. By pressing “M” button, you will see your test record from the most recent to the oldest.
3. Press the "S" button to view the average results, press the "S" button continuously to view the average results sequentially for 7, 14, 21 and 28 days.
4. Please press “M” button to turn off the meter, it is finished when you hear the beep sound.

10. Control solution (optional)

Control solution is used to check if Blood Glucose Meter and Blood Glucose Test Strip are working together properly as a system. Control solution can be used in two ways:

1. To practice the test procedure.
2. To make sure that the Blood Glucose Meter and Blood Glucose Test Strips are working together properly.

IMPORTANT INFORMATION

1. Do not use control solution beyond the expiration date indicated on the bottle label.
2. The discard date for control solution is 90 days after first opening. Record the discard date on the bottle, when you open a new bottle of control solution.



PERFORM A CONTROL TEST

1. Insert a new test strip into the strip slot, the meter will activate. The code number will appear on the screen. Compare the code number shown on the screen against the code number on the test strip vial. If the two numbers match, you may begin test.



2. Gently shake the control solution, discard the first drop and apply the control solution to the right or left edge of the strip. Make sure that the control solution has saturated the test confirmation window.

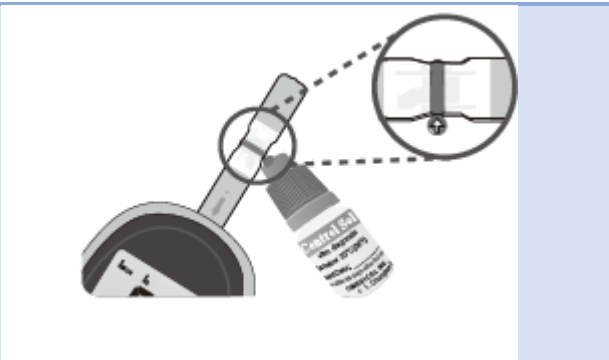

3. Test result will show up in 8 seconds. The result should correspond to the range printed on the label of strip vial used.





NOTE:

REPEAT TEST IF THE RESULT FALLS OUTSIDE THE CONTROL RANGE ON THE CONTROL SOLUTION BOTTLE LABEL. IF YOU CONTINUE TO GET THE RESULT FALLING OUTSIDE THE CONTROL RANGE, YOUR METER AND STRIP MAY NOT BE WORKING PROPERLY. DO NOT USE THE SYSTEM TO TEST YOUR BLOOD UNTIL YOU GET A TEST RESULT FALLS WITHIN THE CONTROL RANGE. CONSULT YOUR LOCAL DISTRIBUTOR FOR HELP.

11. Meter specifications

1.	Assay Method	Electrochemical biosensor
2.	Test Sample	Capillary whole blood from adults only
3.	Test Result	Plasma glucose
4.	Sample Size	0.8µL
5.	Measuring Range	20 - 600 mg/dL or 1.1 - 33.3 mmol/L
6.	Acceptable Hematocrit Range	25% - 65%
7.	Measuring Time	8 seconds
8.	Memory Capacity	180 test results with time/date
9.	Power Supply	One 3V Lithium Battery (CR2032)
10.	Battery Life	Approximately 1000 tests
11.	Operating Temp. Range	10 °C to 40 °C (50 °F to 104 °F)
12.	Operating Relative Humidity	20% - 80% RH
13.	Automatic shut-off	In 3 minutes
14.	Meter storage conditions	Temperature: -25°C to 70°C (-13°F to 158°F) Humidity: 20% - 80% RH
15.	Altitude	8800 feet (2750 meter)

Electromagnetic Compatibility

It is the manufacturer's responsibility to provide equipment electromagnetic compatibility information to the customer or user.



It is the user's responsibility to ensure that a compatible electromagnetic environment for the equipment can be maintained in order that the device will perform as intended.

This product complies with the emission and immunity requirements of EN/IEC 61326-2-6 and EN/IEC 61326-1.

This equipment has been designed and tested to CISPR 11 Class A. In a domestic environment it may cause radio interference, in which case, you may need to take measures to mitigate the interference.

Before using the equipment, the electromagnetic environment should be evaluated prior to operation of it.

Do not use this equipment in close proximity to sources of strong electromagnetic radiation (e.g. unshielded intentional RF sources), as these can interfere with the proper operation.

12. Taking care of your meter

When the meter is dirty, please clean it by wiping gently with a cotton swab or cloth. Avoid use powder to clean meter.

This instrument should not be subjected to extremes in temperatures, humidity, direct sunlight, shock or dust.

REPLACING THE BATTERY

The blood glucose meter's battery life will vary depending on usage, so always keep a spare available. The battery can last about 18 months when testing 2 times a day, total 1000 tests. When the battery symbol appears on the meter display, it means battery is getting low. (FIG. A) You will still be able to test with low battery, but you should replace it as soon as possible. When battery symbol appears flashing on the display, the meter will no longer give results and you must replace the battery immediately. (FIG. B)

NOTE:

- EVERY TIME WHEN YOU REPLACE THE BATTERY, THE METER WILL TURN ON AUTOMATICALLY ENTERING THE TIME/ DATE SETTING.



- PLEASE SET THE CURRENT TIME AND DATE BEFORE TESTING.
- PLEASE REMOVE THE BATTERY IF YOU WILL NOT USE THE METER OVER A LONG PERIOD OF TIME.

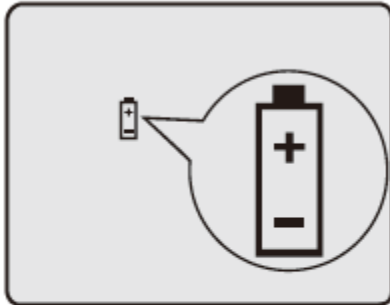

(FIG. A)

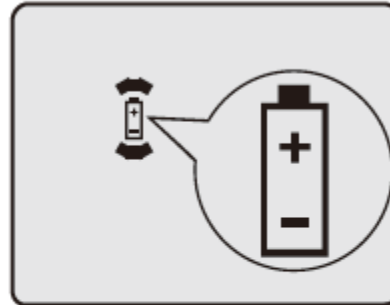

(FIG. B)

TO REPLACE THE BATTERY:

1. Make sure the meter is turned off. Let the front of the meter rest in the palm of your hand. Slide battery compartment door open.



2. Remove the old battery and insert the new 3V Lithium battery into the battery compartment, with the "+" side facing up.



3. Slide battery compartment door closed. Check to see if your meter is working. If it fails to turn on, the battery may have been inserted incorrectly. Remove the battery and reinsert it as illustrated.



CLEANING METER

Caring for your Blood Glucose Meter is easy - just keep it free of dust. If you need to clean it, please follow the guidelines below carefully to help you get the best performance:

Do:

- Make sure the meter is turned off.
- Gently wipe the meter surface with a soft cloth slightly dampened with 75% medical alcohol.
- Make sure that you squeeze off excess liquid from the cloth before you wipe the meter's surface.

Do Not:

- Get any moisture in the code chip slot or test strip slot.
- Spray any cleaning solution directly onto the meter.
- Put the meter under water or liquid.
- Pour liquid into the meter.

STORAGE AND HANDLING

Keep your meter free of dust. Protect it from extreme temperature and humidity.

13. Disposing your meter





During blood glucose measurement the meter itself may come into contact with blood. Used meter may carry a risk of infection. Please dispose of your used meter properly after removing

the battery according to the regulations applicable in your country. For information about correct disposal please contact your local council and authority.

The meter falls outside the scope of European Directive 2012/19/EU (Directive on waste electrical and electronic equipment (WEEE)).

14. Displaying messages and troubleshooting

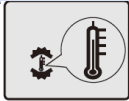
As listed below are problems that may appear with your Blood Glucose Meter when performing a test. These messages will help you to identify certain problems. If you have any concerns or see any other error display, please contact us or the local distributor for help.

DISPLAY	DESCRIPTION	ACTION TO TAKE
	Display check	If some parts of the display do not work Contact your local distributor for help.
	Blood glucose result may be higher than 33.3 mmol/L or 600 mg/dL.	If this is not confirmed by the way you feel, review proper testing procedure and perform a quality check with control solution. Repeat blood test, if “HI” still appears, call your doctor’s immediately.
	Blood glucose result may be lower than 1.1 /L or 20mg/dL.	If this is not confirmed by the way you feel, review proper testing procedure and perform a quality check with control solution. Repeat blood test. If “LO” still appears, call your doctor’s immediately
	Temperature is above or below the operating range of test strips	The result you have obtained may not be accurate. Move to an area with temperature between 10°C to 40°C (50°F - 104°F). Do not artificially heat or cool the meter.
	Battery is dead.	Change battery now
	Test strip may be damaged or test was not performed correctly.	Perform the test with new test strip and follow the test procedure correctly.



	Test strip is used	Perform the test with a new test strip only.
No responses when strip is inserted into the meter	Maybe: 1. Battery is dead 2. Wrong strip is inserted 3. Meter is defective	You have to: 1. Replace battery 2. Insert the test strip correctly 3. Contact us for help
No responses when blood sample is applied to the strip.	Maybe: 1. Blood sample is not sufficient 2. Meter is defective	You have to: 1. Repeat test with sufficient sample 2. Perform Meter Quality Check by inserting check strip.

NOTE:

If there is any error message displayed but not listed here, or your meter shuts down for no reason, you can reset the meter or replace the battery.